

# A Guide to Fire and Security Protection in Multi-Occupied Residential Properties



Revision 2015

Advice for Property Owners,  
Managers and Contractors

# Foreword

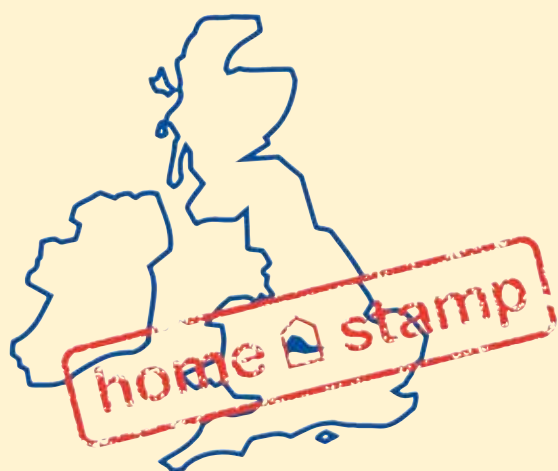

[www.homestamp.com](http://www.homestamp.com)

Partners signed up to the Homestamp Consortium are listed on page 103. Organisations continue to join us, so look on our website for the latest list of partners.

HOMESTAMP is a partnership consortium with an interest in private sector housing comprising of Local Authorities, the Private Rented Sector, West Midlands Police and West Midlands Fire Service.

Our aim is to:

- Encourage the supply of good quality private rented homes
- To provide and facilitate information and training for landlords
- To consider and respond to regional and national issues affecting the private rented sector
- To encourage joint working between all interested parties

The objective of this document is to provide owners, managers, letting agents and contractors with the necessary information which will help them provide their tenants with safe and high quality accommodation, and reduce the need for intervention from local authorities.

## Disclaimer

The information contained in this guide is only for general guidance and information purposes. The law as stated relates to the countries of the United Kingdom. It should not be regarded or relied on as a complete or authoritative statement of the law. The application and impact of laws can vary widely based on the specific facts involved and the information in this guide is not a substitute for specialist advice for your particular circumstances. Given the changing nature of laws, rules and regulations, and the inherent hazards of electronic communication, there may be delays in obtaining, omissions or inaccuracies in the information contained in this guide.

We have made attempts to ensure that the information contained in this guide has been obtained from reliable sources. However, the Homestamp Consortium is not responsible for any errors or omissions including any misleading statements, or for the results

obtained from the use of this information. The Homestamp Consortium does not represent or warrant that the information accessible through this guide is accurate, complete, up to date or that it will be provided in a timely manner or the results which will be obtained from the use of this information.

Under no circumstances will the Homestamp Consortium, its related partnerships or partners, agents or employees thereof be liable to you or anyone else for any loss, damage or inconvenience arising as a consequence of any use of or the inability to use any information in this guide.

Information contained as part of this guide and checklist pertaining to Homestamp is provided as of the date of its production.

Copyright permission allows for reproduction or copying of this document for use by landlords, tenants or similar agencies for non-commercial use.

© Homestamp 2015

Homestamp Consortium, Highfield House Business Centre, 1562-1564 Stratford Road, Hall Green, Birmingham B28 9HA  
Design and artwork produced by zevolution : [www.zevolution.co.uk](http://www.zevolution.co.uk)

# Contents

<b>Introduction</b>	4-7
<b>Chapter 1: Fire precautions</b>	8-12
<b>Chapter 2: A Guide to carrying out a Fire Risk Assessment in Multi-Occupied Residential Property</b>	13-16
Detailed Fire Precautions Key Symbols	17
<b>Chapter 3: Typical shared house accommodation layouts</b>	18-29
Plan 1: Pre-1919 two storey shared house with stairway off living room	18
Plan 2: Pre-1919 two storey shared house with stairway off living room (alternative)	21
Plan 3: Pre-1919 two storey shared house with stairway off hall	24
Plan 4: Typical three storey shared type Victorian house	27
<b>Chapter 4: Typical bedsit accommodation layouts</b>	30 – 47
Plan 5: Typical pre-1919 two storey bedsit house with stairway off living room	30
Plan 6: Typical pre-1919 two storey bedsit house with stairway off living room (alternative)	33
Plan 7: Typical two storey bedsit type Victorian house	36
Plan 8: Typical two storey bedsit type Victorian house (alternative)	39
Plan 9: Typical three storey bedsit type Victorian house	42
Plan 10: Typical three storey bedsit type Victorian house (with cooking facilities in lets)	45
<b>Chapter 5: Typical layout of buildings converted into flats</b>	48 – 65
Plan 11: Typical two storey Victorian house divided into two self-contained flats	48
Plan 12: Typical two storey Victorian house divided into two self-contained flats (Travel distance: excessive)	51
Plan 13: Typical two storey Victorian house divided into two self-contained flats (Travel distance: excessive) (alternative)	54
Plan 14: Typical three storey Victorian house divided into self-contained flats	57
Plan 15: Typical three storey Victorian house divided into self-contained flats (Travel distance: excessive)	60
Plan 16: Typical three storey Victorian house divided into self-contained flats (Travel distance: excessive) (alternative)	63
<b>Chapter 6: Maintenance of fire protection</b>	66-67
<b>Chapter 7: Fire prevention</b>	68-69
<b>Appendices</b>	70-101
<p>Appendices give detailed technical information and guidance.</p> <p>Sample forms, for use when recording tests and fire risk assessment findings can be found in Appendix 13</p>	
<b>Notes</b>	102
<b>Homestamp Consortium partners</b>	103

# Introduction

**“A Guide to Fire and Security Protection in Multi-Occupied Residential Properties - 2012”** updates all contact information and useful links. The advice contained in the main guide of the 2009 edition remains current and correct.

National guidance on fire safety within residential accommodation was launched by LACORS on 23rd July 2008.

LACORS (Local Authority Co-ordinators of Regulatory Service) is an organisation that advises local authorities on best practice in enforcing regulations. Although the LACORS national guidance is not law, its recommended standards have nevertheless, been adopted widely by local authorities and fire authorities.

The LACORS guidance adopts a risk-based approach to fire safety and compliance with the guidance normally satisfies the legal requirements of both the Housing Act and the Regulatory Reform (Fire Safety) Order 2005.

This guidance, entitled **“Housing - Fire Safety (Guidance on fire safety provisions for certain types of existing housing)”** can be downloaded at [www.homestamp.com/downloads](http://www.homestamp.com/downloads)

The Homestamp **“Guide to Fire Safety and Security Protection in Multi-Occupied Residential Properties”** complements the LACORS guidance, by enhancing the practical advice for landlords on how to carry out fire risk assessment and offering fire safety solutions in the form of detailed plans and appendices having regard to typical occupancy, ensuring that vulnerable occupants are better protected.

The Fire Safety Order places a legal obligation on landlords to carry out a risk assessment in the common parts of HMOs (Houses in Multiple Occupation) and buildings comprising self-contained flats, and to provide any fire safety measures that the risk assessment shows to be necessary. Common parts include shared kitchens, bathrooms, living rooms and stairways.

In practice this requires a risk assessment of the entire building, not just common parts, because fire safety measures for common and private parts of HMOs and buildings comprising flats are designed as a whole integrated ‘package’.

Landlords complying with the LACORS guidance will be satisfying their legal obligations under the Fire Safety Order.

Note that the Fire Safety Order does not apply to shared HMOs. These are properties occupied by tenants on a single group contract (typically students) who tend to live together as a single household, collectively have control of all parts of the house and normally have their own bedroom but share the kitchen, bathroom and living room. This means carrying out a risk assessment is not a legal requirement but which should be done in any event as standard good practice.

Voluntary compliance with LACORS guidance by landlords would mean that it would be unlikely that further fire safety measures would be required at compliant properties, if an inspection was carried out by a Fire Safety Enforcement Officer.

# Introduction

## Houses in Multiple Occupation (HMO)

### Definition of HMO:

**“House in Multiple Occupation” means a building, or part of a building (e.g. a flat):**

- which is occupied by more than one household and in which more than one household shares an amenity (or the building lacks an amenity) such as a bathroom, toilet or cooking facilities; or,
- which is occupied by more than one household and which is a converted building which does not entirely comprise of self contained flats (whether or not there is also a sharing or lack of amenities); or,
- which comprises entirely of converted self contained flats and the standard of conversion does not meet, as a minimum, that required by the 1991 Building Regulation and at least one third of the flats are occupied under short tenancies.

**And** is “occupied” by more than one household:

- as their only or main residence, or,
- as a refuge by persons escaping domestic violence, or,
- during term time by students, or,
- for some other purpose that is prescribed in regulations.

**Note:** households comprise:

- families (including single persons and co-habiting couples (whether or not of the opposite sex), or,
- any other relationship that may be prescribed by regulations, such as domestic staff or fostering or carer arrangements.

The Government believes that safe and properly managed HMOs fulfill an important function in the private rented housing market. Many people need access to cheap flexible accommodation and in most areas HMOs meet this need. HMOs also have a particular role in providing affordable accommodation in areas of high housing demand where rents are high.

HMO accommodation has often been created by sub division of larger properties into smaller units and may pose fire risks to occupants as traditional means of escape may have been compromised in the process of redevelopment.

HMOs can also be home to vulnerable tenants and a higher standard of safety is required in order to ensure the safety of those tenants and their neighbours.

Therefore this document has been developed to provide guidance to owners, managers, letting agents and contractors on best practice in meeting fire safety and security standards in HMOs.

# Introduction

## Definition of Shared House and Bedsit:

Throughout this document you will find many references to accommodation which is described as “bedsits” or “shared houses”.

Under previous legislation the difference was important because a shared house could be regarded as falling outside the legal definition of an HMO and thus the laws relating to HMOs could not be enforced.

With the introduction of the Housing Act 2004 this has changed and now the definition of an HMO depends on a number of factors.

**However, in nearly all cases, if there are three or more unrelated tenants living in a house then the house will fall within the definition of a House in Multiple Occupation.**

However LACORS recognises that, despite all relevant houses being HMOs, there are some differences between accommodation termed as “bedsits” and accommodation described as a “shared house”. There are aspects of living in a shared house which may reduce the risk of fire and therefore the necessary fire precautions can be reduced to some extent.

### What is a shared house?

The working guidance given in LACORS is that for an HMO to be regarded as a shared house, it should:

- be rented by an identifiable group of sharers, such as students, work colleagues or friends, as **joint tenants**. This means that they will generally commence their occupation at roughly the same time and be jointly and severally liable for paying the rent and complying with tenancy conditions
- each occupant will have a designated study/bedroom but will share the kitchen, bathroom, living and dining rooms and all other parts of the house. Each tenant will have a right of access to all parts of the house, including others’ study/bedrooms.

In addition, the following criteria can also be used to help decide whether the house can be regarded as shared:

- there will be a significant degree of social interaction between the tenants
- the tenants will share facilities such as laundry equipment and television, etc
- there will be arrangements in place for the tenants to share the cleaning and general management of the whole house
- bedroom/study doors will not have locks.

# Introduction

the true manner of occupation, it is likely to be accepted.

- the responsibility for finding a new tenant, if one moves out, will rest with the remaining tenants rather than the landlord
- tenants will decide amongst themselves who is to occupy each study/bedroom
- the total occupancy of the house will be relatively small. Shared houses rarely have more than seven tenants
- the occupancy of the house will be relatively stable. Frequent changes in occupier would suggest a bedsit
- there will be a degree of co-operation and sharing of common tasks such as shopping, cooking, cleaning etc.
- tenants will normally be aware of who is in the house at all times.

The listed criteria are important but are not prescriptive. Some variation is acceptable. The important thing is that to be regarded as a shared house, the occupants must live together in a manner which approximates to single family occupation.

If an HMO is not a shared house then it will be regarded as bedsits.

In some instances, however, a house will not fall neatly into one classification or the other, and in such a case will need to be treated on its merits. As long as the risk assessment takes into account the risks associated with

# Chapter 1: Fire Precautions

The fire precautions that the Local Authority require are mostly about things that can happen outside the residents' control. The law takes the view that someone with overall control of the house, (i.e. the owner, landlord or manager) must take steps to protect everyone living in it. **The main reasons for insisting on fire precautions in Houses in Multiple Occupation (HMOs) is to provide early warning and stop the smoke and fire spreading to other parts of the house before other residents have the chance to escape.**

The advice given in this guidance comes in two parts. Firstly how to carry out a fire safety risk assessment and secondly, recommended fire safety measures for common property types. The two parts are used in conjunction.

Users of this guide should familiarise themselves with how to carry out a risk assessment (Chapter 2 on page 13). Then refer to the property layout plans in Chapters 3, 4 and 5 to decide which best suits their own property and then adjust the recommended fire safety measures based on a risk assessment of their own property.

The guidance given in this section is designed for HMOs as they are commonly encountered in most areas: that is to say HMOs of two or three storeys (not including hostels) housing up to approximately twelve people. For houses larger than this or where the layout is unusual or combined with commercial premises the person with overall control should contact the Local Authority for advice as a higher standard of fire protection may be required.

Alternatives to the guidance are acceptable if they afford at least the same level of protection.

One example of this would be the installation of a sprinkler system (see Appendix 10: Automatic fire suppression systems). It is possible that a designed commissioned sprinkler system could take the place of some of the fire precautions listed in this booklet. It would, however, be up to the landlord to investigate the practicalities and economics of such schemes; following the guidance should result in acceptable fire safety. However, where the property is unusual in design or is used to house vulnerable groups of people (for example infirm or drug dependant people) the Local Authority may well require higher standards.

If you are proposing to convert or alter a property, it is important to remember that you may require Planning Permission and / or Building Regulation Approval first. Additionally, regard should also be had to the fact that there are further requirements under Housing Act legislation, for example, space and amenity standards which also need to be met.

The next section sets out the general principles for the fire precaution standards and is followed by the recommended requirements the Local Authority has adopted. Chapters 3 and 4 illustrate some typical schemes for houses commonly used for multiple occupancy in most areas.



## General principles

The following diagram illustrates the general principles of fire precautions in a representative house.

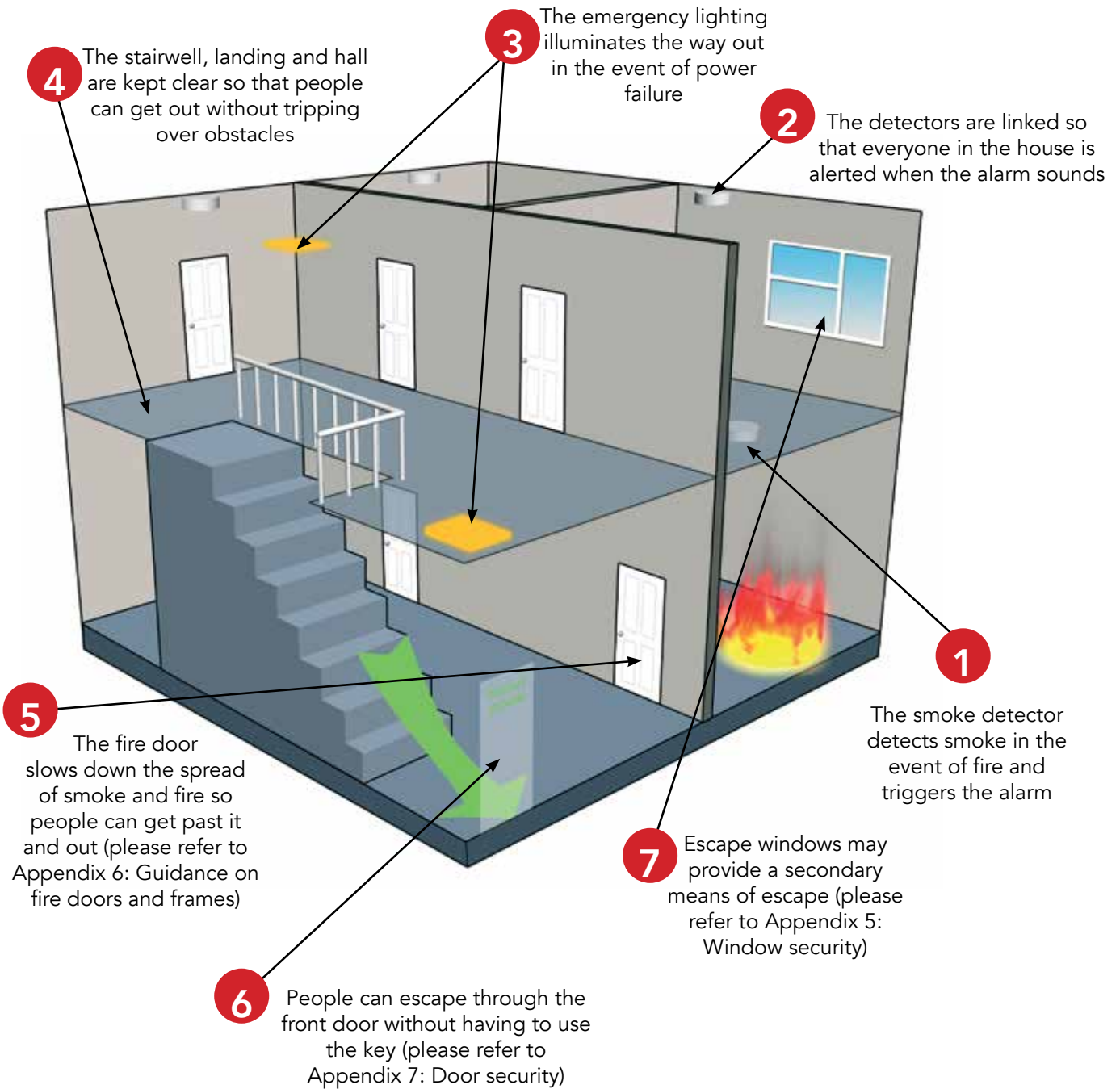

## Chapter 1: Fire Precautions

### Notes:

- 1) There is a mains operated detector/ alarm where necessary. This ensures that fires are detected at the earliest opportunity and that a warning is sounded.
- 2) Whilst the fire precautions should help everyone escape from the house, the main objective of the scheme is to alert people in other rooms that there is a fire, as well as the occupier of the room where the fire starts.
- 3) If the electricity supply is interrupted the emergency lighting illuminates the escape route to show people the way out where necessary.
- 4) There is a clear way out through a route free of fire risks and obstructions. No one has to pass through a room of significantly higher fire risk in order to escape.
- 5) All rooms which pose a significant risk of fire have 30 minute fire resisting doors with smoke seals and self-closing devices. Fire doors are provided to protect the means of escape and should **never** be wedged open. Self-closing devices should normally be fitted to fire doors and always to entrance doors to bedsits and flats. However, this may be relaxed for fire doors inside singly occupied flats and low risk shared HMOs. Doors to rooms within larger multiply occupied flats and larger shared HMOs may require self closers within the context of an overall risk assessment (please refer to Appendix 6: Guidance on fire doors and frames).
- 6) Escape routes must have doors that cannot be locked or fastened in such a way that prevents them from being easily and immediately opened, in the event of an emergency by persons on their way out, without the use of a key (please refer to Appendix 7: Door security).
- 7) Escape windows can be used as a secondary means of escape at ground or first floor level, only where the ground below is flat and free from hazards (low walls, railings etc) (please refer to Appendix 5: Window security).

### Firefighting equipment

The provision of fire blankets and extinguishers can be useful if all residents are **properly** instructed on how to use them. They must know how to hold and use a fire blanket and be instructed in how to discharge any fire extinguisher provided, what type of fire it is safe to be used on, how to tackle a fire safely with an extinguisher and when to give up and get out.

Landlords should consider the following points where extinguishers are to be provided:

- the extinguishers must comply with BS 5423 (or equivalent), which includes the specification for portable extinguishers
- where extinguishers are provided they should be mounted on brackets fixed to the wall with the carrying handle no more than one metre high in the escape route at each floor level
- all extinguishers should be maintained in accordance with BS 5306 (or equivalent)
- the installation of extinguishers can lead to ongoing management problems where equipment is discharged through malice or horseplay
- in the event of a fire, residents should be under the instruction to evacuate the building. However, extinguishers may provide a means of tackling small fires if it is considered safe to do so.

Certainly fire blankets and extinguishers can be helpful in tackling small fires and stopping them from becoming out of control.

However, there are a number of injuries every year because people do not know how to use fire extinguishers and blankets properly, or do not appreciate the limitations of these devices. **Unless a fire is very small, it is best on balance to encourage people simply to get out of the building quickly.**

## Travel distances

Travel distances within HMOs are an important matter. In the event of fire, occupiers need to be reasonably sure that they can reach a place of safety within reasonable time. The layout of the premises needs to be such that occupiers can quickly find their way across the room they are in and then through any protected route to the final exit. This must be achieved despite possible heat, flames and most importantly smoke. Smoke is often toxic but can also reduce visibility both by fogging and by causing irritation to the eyes. Occupiers need to be able to get through the escape route with a minimum of exposure to these hazards particularly by inhalation.

Like most elements of fire safety, judging the adequacy of travel distances is a matter of risk assessment and needs to be considered along with all other risks.

As a guideline however:

**The distance between any point on the premises and a place of safety should ideally be a maximum of 9 metres.** A place of relative safety would, for example, be a protected route within the building.

In HMOs without a protected route (for example in smaller two storey shared houses) the travel distance will generally need to be calculated from the furthest corner of the most distant bedroom to the front door. The distance will often exceed 9m.

Where 9m travel distance is exceeded, landlords should consider this as an item of additional risk. Some examples of the ways that excessive travel distances can be offset are:

- alternative escape measures (e.g. an escape window) or routes;
- better smoke detection or coverage;
- additional emergency lighting.

Premises converted after 1991 with full Building Regulation Approval should already comply with travel distance requirements.

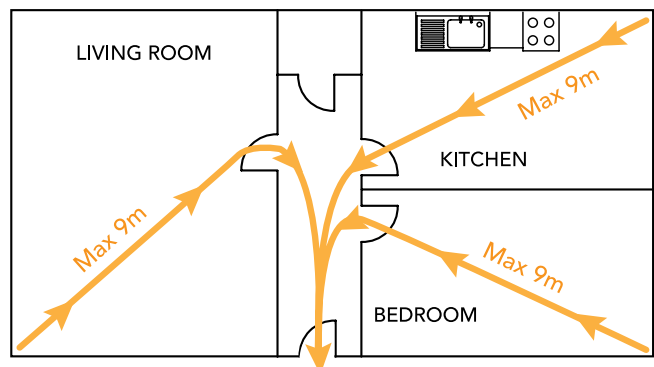

**Place of relative safety or protected route**

# Chapter 2: A Guide to carrying out a Fire Risk Assessment in Multi-Occupied Residential Property

## A practical step-by-step guide

As explained below you need to assess the fire risk in your HMO to decide if you need to increase or reduce the fire precautions recommended by LACORS and Homestamp. Keep records of everything you have done to show you meet your legal requirement to carry out a full fire risk assessment (sample forms can be found at Appendix 13).

To do this, start by **assessing how vulnerable to risk your tenants are**.

Consider the most vulnerable that you are likely to house i.e. worst-case scenario.

**Record your assessments.** Remember you need to reassess the vulnerability of any new tenants if there is a significant difference in their ability to escape from fire e.g. if they have less mobility.

Next, **look for anything in your property that could start a fire or burn** – advice on this is given later. **Record your findings.**

You now need to **reduce the overall fire risk** by simply removing or reducing the numbers of sources of fire and flammable materials wherever it is possible to do so. **Record what you have done.** Also check that appliances provided by you are being used and maintained as per the manufacturer's advice.

**Always keep a record of your fire safety checks and any works carried out as this may reduce your legal liability if there is a fire. You may be asked to produce this as evidence that you have met your legal requirements to carry out a fire risk assessment.**

Having reduced the sources of ignition and flammable materials, consider next, any **other risks** remaining in your property.

**Record your findings.** The things that you need to consider are listed later.

Now decide what **precautions are needed to reduce these remaining risks** should a fire start. These are normally early warning (fire detection) system, a safe escape route and firefighting equipment. The LACORS and Homestamp recommendations will help you make these decisions. **Record your decisions.**

Firstly, decide what grade of **fire warning system** is suitable and which parts of the property it needs to cover. The warning system then needs to be fitted in accordance with the manufacturers instructions and you should **record full details of this work.**

You also need to assess whether the **escape route** would give tenants sufficient time to get out of the building safely in the event of a fire (consider the effects of smoke and hot gases in addition to flames). You may need to upgrade the fire resistance of the escape route by providing fire doors and over-boarding some ceilings, walls and under stairs. **Record your findings.**

If the escape route is long, complex and without borrowed light you may need to fit

## Chapter 2: A Guide to carrying out a Fire Risk Assessment in Multi-Occupied Residential Property

(and maintain) **emergency lighting. Record your findings.**

Having provided fire safety measures in accordance with your risk assessment you now need to **provide your tenants with written information** on how to prevent, and what to do in case of fire, including displaying a notice in the building saying where, outside the building, occupiers should meet so that everyone can be accounted for. You should also provide the fire safety information to anyone employed to work on your property. **Record what you have done.**

**Fire alarm and emergency lighting systems, fire extinguishers and fire doors** need to be regularly **tested, checked and maintained.** So your fire risk assessment needs to include deciding on and setting up a fire safety management routine. **Record your planned maintenance.**

Finally you will need to **periodically review the adequacy of your fire precautions,** particularly on a change of tenancy, and taking account of age and wear and tear, and change, upgrade or replace as necessary. **Record it every time you do this.**

### Typical flammable materials

For example, things that will burn relatively easily, and in large enough quantity to provide fuel for a fire or cause it to spread to another fuel source. **Make a complete record of everything present in the building.**

These include:

- furniture, furnishings, textiles, bedding, clothing and curtains, laundry;
- accumulations of unwanted mail, waste paper, cardboard, newspapers and magazines (including that waiting recycling collection);
- waste storage and refuse containers;
- flammable liquid-based products such as paint, varnish, thinners, adhesives, white spirit, methylated spirit and cooking oils;
- liquefied petroleum gas (LPG), paraffin, heating oils and petrol;
- paper products, packaging materials, stationery, advertising materials and books
- decorations for seasonal and religious occasions;
- Plastics and rubber such as video tapes polyurethane foam-filled furniture and polystyrene-based display materials;
- wall, floor and ceiling coverings and surface finishes.

### Typical sources of ignition

For example, sources of heat that could get hot enough to ignite any materials around them. **Make a complete record of everything present in the building.**

These include:

- naked flames, e.g. candles and night lights;
- electric, gas or oil-fired heaters (fixed or portable);
- heating boilers;
- cookers, toasters and other kitchen equipment (especially when shared);
- faulty or misused electrical equipment;
- electrical blankets, computers, TVs, washing machines and dryers;
- lighting equipment (fixed and movable) e.g. halogen lamps and table lamps;
- the electrical installation;
- the gas installation;
- arson attack;
- in larger or mixed use properties, any plant room e.g. lift motor rooms;
- smoker's materials e.g. cigarettes, matches and lighters.

### Matters affecting fire risk

As part of your risk assessment you should consider the following items because they can contribute to an increased fire risk.

Inspect your property and make a note of anything on this list that would increase or decrease fire risk. These need to be considered when you are making a judgement as to your property being low, medium or high fire risk.

If your property is **medium** risk the Homestamp and LACORS guidance will normally apply.

If your property is **high** risk, then additional fire precautions to these recommended by the guides may be necessary.

If your property is **low** some of the recommendations may be relaxed.

**Make a complete record of everything in your building and the level of risk you have decided on.**

- Escape route  
*Is there an escape route capable of enabling tenants to evacuate the property safely in the event of fire?*
- Habitable basement  
*Are there habitable rooms in the basement in which people could become trapped?*
- Unoccupied basements / cellars  
*Do these contain rubbish and other flammable materials?*

## Chapter 2: A Guide to carrying out a Fire Risk Assessment in Multi-Occupied Residential Property

- Inner rooms  
*Does a tenant have to go from one room through another in order to get to the escape route and thereby risk becoming trapped?*
- Escape windows  
*Does the window have the minimum of 0.33msq opening area and is no higher than 1.1 metres from the floor? Is the room containing the window no higher than the first floor?*
- Protected routes, stairs  
*Does the escape route and stairs allow the occupiers sufficient time to get out of the building without injury from fire or smoke?*
- Exit doors  
*Where locks are fitted to doors that form part of the escape route, are they able to be opened from the inside without the use of a key?*
- External stairways  
*Is there a well-maintained external staircase?*
- Fire separation / compartmentation  
*Does the construction between units of accommodation have at least 30 minutes fire resistance?*
- Fire doors  
*Do fire doors have a minimum rating of 30 minutes?*
- Automatic fire detection and warning systems  
*Is there a hard-wired interlinked smoke / heat detection system in place?*
- Lighting of escape routes  
*Would the escape route have sufficient lighting to enable escape in the event of fire?*
- Emergency escape lighting  
*Is the escape route long and complex and does it have borrowed lighting?*
- Firefighting equipment (portable)  
*Are there suitable fire extinguishers and / or fire blankets in appropriate places?*
- Automatic water suppression systems  
*Is a sprinkler system provided?*
- Fire safety signage  
*Is the escape route long and complicated, and if so, are there signs to guide tenants out?*
- Surface finishes  
*Are there any flammable materials on the walls and ceilings?*
- Escape route floor coverings  
*Does the floor comply with BS 4790 – the standard for materials having low fire spread?*
- Management and maintenance of fire safety  
*Have you got records showing that both essential service (gas / electricity) and fire safety equipment and systems are being properly maintained?*
- Special provisions relating to back-to-back houses  
*If you are letting a house of this type seek guidance from your Local Authority.*
- Mixed commercial and residential use  
*If you are letting a building of this type seek guidance from your Local Authority / Fire and Rescue Service.*

**Keep a complete record of all your findings, alterations, additions and any guidance you have used.**

Fire risk assessment documentation can be found at Appendix 13: Sample forms.



# Detailed Fire Precautions Key Symbols

The following pages include some typical examples of house layouts and the work needed to make them comply with fire safety requirements. Please refer to Introduction (pages 6 and 7) for Shared House / Bedsit definitions.

Remember that these are **suggested** ways of complying with the basic principles. There may be other options and the Local Authority is always open to discussion.

## Key Symbols used in the following layout plans



Mains powered with battery back up, interlinked, combined smoke detector and sounder



Control panel



Mains powered with battery back up, interlinked, combined heat detector and sounder



Area to be covered by emergency lighting



Smoke detector linked to control panel



30 minute fire resisting door incorporating intumescent strip (FD30)

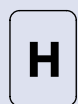

Heat detector linked to control panel



30 minute fire resisting door incorporating intumescent and cold smoke seals (FD30S)



Mains powered single point smoke detector and sounder with battery back up



30 minute fire resisting wall/partition

Escape window



Manual call point (Break Glass)

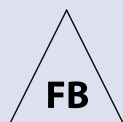

Fire Blanket

You should note that where you see symbols on a plan it doesn't mean that it has to be positioned at exactly that point in the actual room. You should refer to the manufacturer's directions and British Standards guidance.

For an explanation of the terms 'intumescent' and 'cold smoke seals' see Appendix 6.

# Chapter 3: Typical shared house accommodation layouts PLAN 1

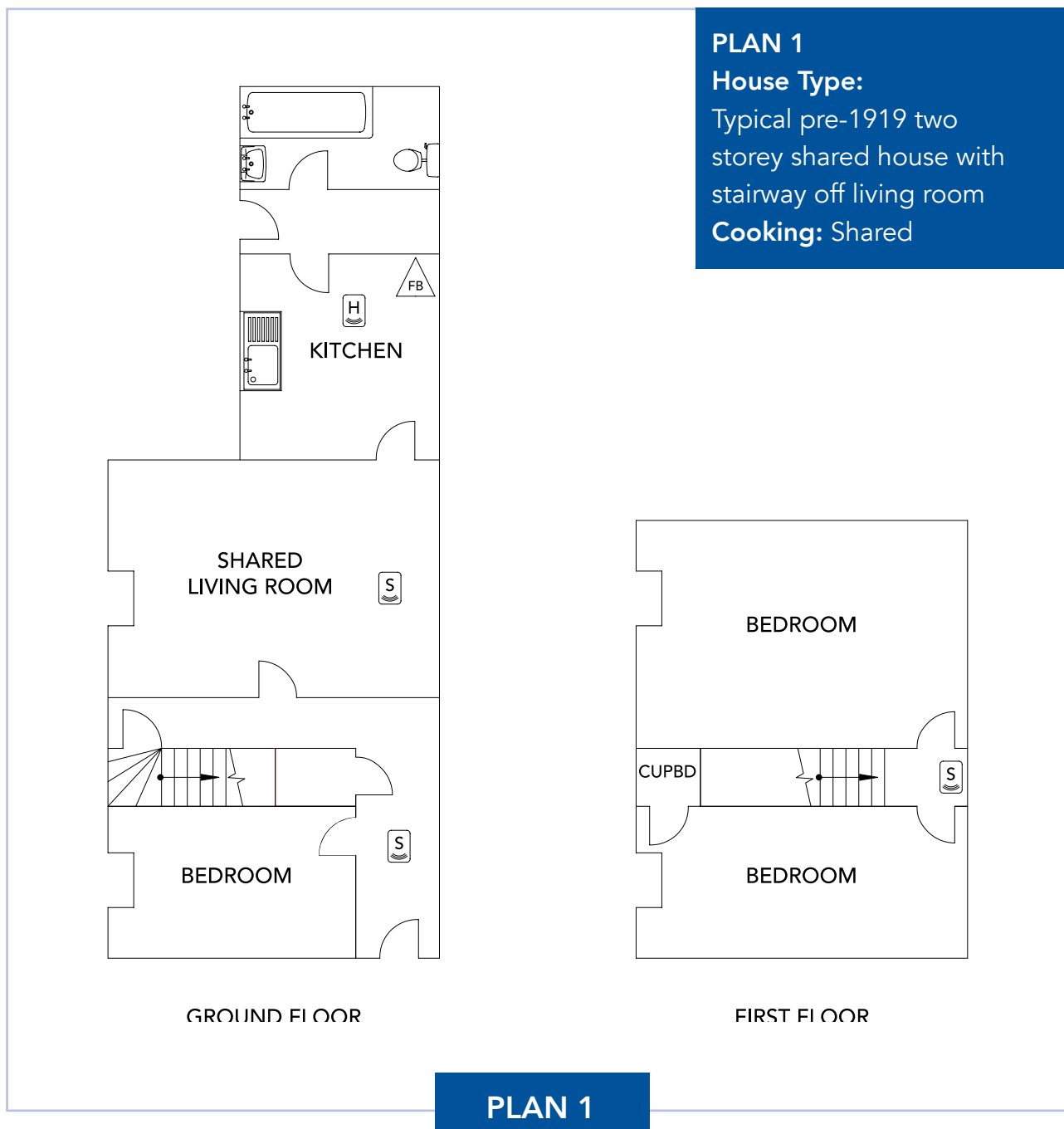

The most likely room in the house for a fire to occur is the kitchen. A fire in the kitchen means smoke could quickly spread to the living room.

A properly constructed partition (see Appendix 3) in the shared living room will allow the occupants to vacate the premises safely in the event of a fire.

By providing a detector/ sounder in the communal areas, anyone upstairs or indeed anywhere in the house will quickly be alerted if there is a fire and should be able to get down the stairs quickly to safety through the front door.

## Chapter 3: Typical shared house accommodation layouts PLAN 1

<b>SCHEDULE TO PLAN No. 1: Typical pre-1919 two storey shared house with stairway off living room and shared cooking facilities</b>	
<b>Detection/Warning</b>	<p>A system of mains powered automatic smoke detectors with battery back up, to achieve a Grade D system in accordance with the current BS 5839 Part 6 (or equivalent), must be installed.</p> <p>In kitchens a heat detector, rather than a smoke detector, must be installed.</p> <p>All detectors must be interlinked, so that if one detector is triggered the alarm sounds in each and every alarm location.</p> <p>There are two types of smoke detector, 'ionisation' and 'optical'. Optical detectors are better in most situations, because they are less likely to give false alarms. See Appendix 1: Automatic fire detection and alarm systems, for further details.</p>
<b>Control Panel</b>	Not required
<b>Emergency Lighting</b>	<p>Subject to a fire risk assessment emergency lighting should not be necessary, provided that the escape route is not long or complex and there is effective artificial or borrowed lighting.</p> <p>Where emergency lighting is considered to be necessary, it should be provided in accordance with the current BS 5266 Part 1 (or equivalent) to cover the protected escape route.</p> <p>The location of light fittings is to be determined by the design / installing engineer. See Appendix 2: Emergency lighting for further information.</p>
<b>Escape Route</b>	<p>The escape route is to allow for residents from all parts of the building to reach the outside without passing through a higher fire risk area. The escape route <b>MUST</b> be kept clear of obstructions and combustible materials. The walls and ceilings of all parts of the escape route <b>MUST</b> be free of highly flammable materials i.e. polystyrene tiles or heavy flock wallpaper.</p>

## Chapter 3: Typical shared house accommodation layouts PLAN 1

SCHEDULE TO PLAN No. 1: Typical pre-1919 two storey shared house with stairway off living room and shared cooking facilities	
<b>Fire Doors</b>	<p>The fitting of fire doors is not required.</p> <p>Solid timber and panelled interior doors are acceptable as long as they are well fitted and of sound and solid construction.</p>
<b>Security of Doors</b>	<p>Locks on final exit doors and any bedrooms must be capable of being opened from the inside without the use of keys. In addition, to improve the overall security of the property and to comply with advice from the Association of British Insurers, it is recommended that BS8621 mortice locks fitted with thumb turns are used on the exit doors; this is a mortice lock (sometimes called a sashlock) which conforms to British Standard BS8621 fitted with a 6 pin cylinder thumb turn.</p> <p>The final exit doors should also be solid and at least 44mm (1<sup>3</sup>/<sub>4</sub>" ) thick and certified to British Standard PAS 24-1 'Doors of Enhanced Security'. For more information about BS8621 mortice thumb turn locks and PAS 24-1 doors please refer to the relevant section in Appendix 7: Door security.</p>
<b>Fire Blankets</b>	<p>A fire blanket to BS 6575 (or equivalent) is to be provided in the kitchen. The blanket must be mounted on the wall 1.5m high adjacent to an exit door away from the cooking facility.</p>
<b>Extinguishers</b>	<p>For further guidance see page 11.</p>
<b>Other recommendations</b>	<p>Polystyrene ceiling tiles <b>should not</b> be used within the premises.</p> <p>Heaters – portable heaters using gas cylinders or flammable liquids <b>should not</b> be used or stored in the premises.</p>

# Chapter 3: Typical shared house accommodation layouts

## PLAN 2

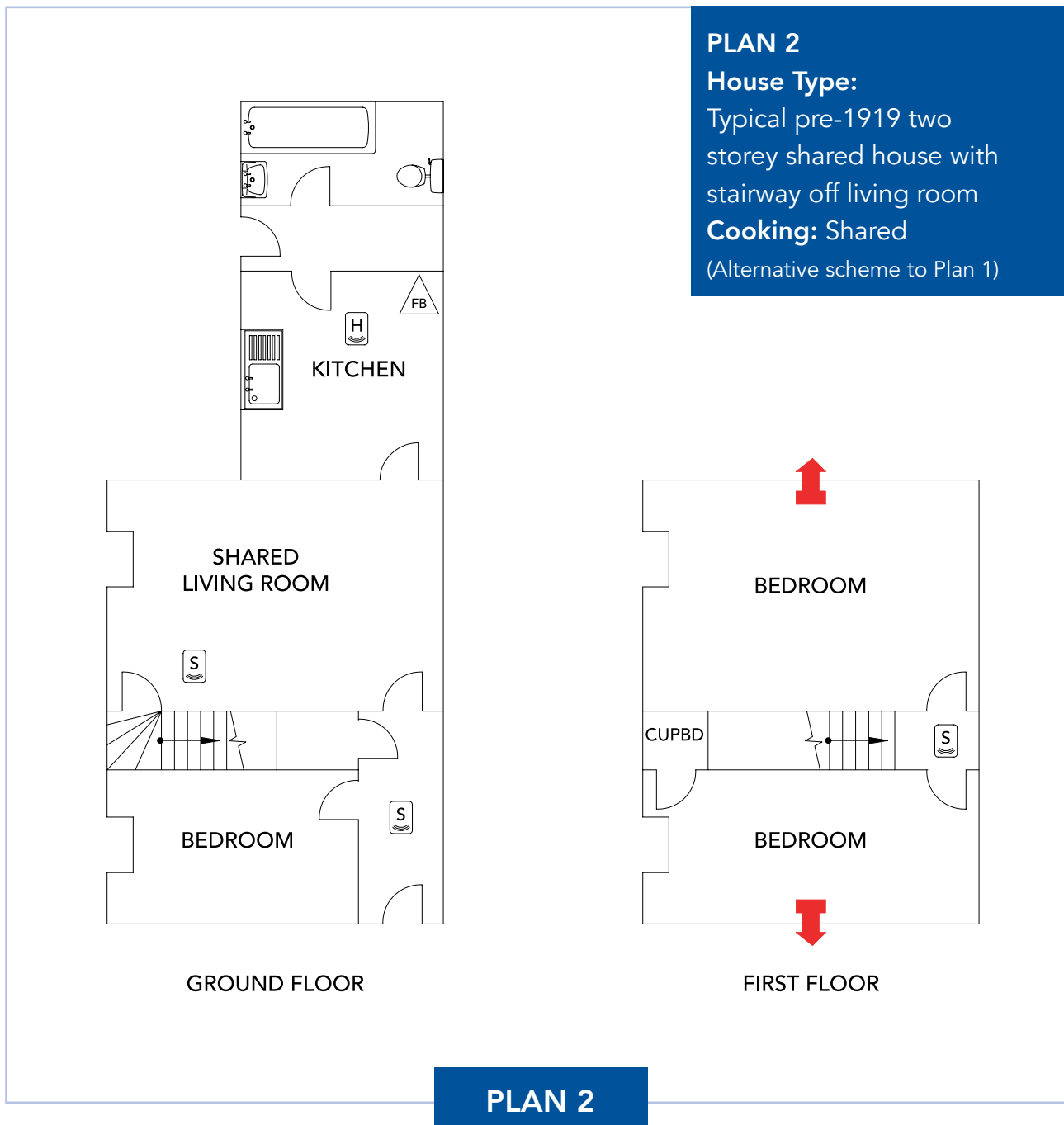

Alternatively, to the preferred option of Plan 1, means of escape can be achieved by providing a detector/sounder in the communal areas and providing escape window openings from the first floor habitable rooms to provide a secondary means of escape in the event that the primary escape route is compromised.

## Chapter 3: Typical shared house accommodation layouts PLAN 2

<b>SCHEDULE TO PLAN No. 2: Typical pre-1919 two storey shared house with stairway off living room and shared cooking facilities (Alternative scheme to Plan 1)</b>	
<b>Detection/Warning</b>	<p>A system of mains powered automatic smoke detectors with battery back up, to achieve a Grade D system in accordance with the current BS 5839 Part 6 (or equivalent), must be installed.</p> <p>In kitchens a heat detector, rather than a smoke detector, must be installed.</p> <p>All detectors must be interlinked, so that if one detector is triggered the alarm sounds in each and every alarm location.</p> <p>There are two types of smoke detector, 'ionisation' and 'optical'. Optical detectors are better in most situations, because they are less likely to give false alarms. See Appendix 1 for further details.</p>
<b>Control Panel</b>	Not required
<b>Emergency Lighting</b>	<p>Subject to a fire risk assessment emergency lighting should not be necessary, provided that the escape route is not long or complex and there is effective artificial or borrowed lighting.</p> <p>Where emergency lighting is considered to be necessary, it should be provided in accordance with the current BS 5266 Part 1 (or equivalent) to cover the protected escape route.</p> <p>The location of light fittings is to be determined by the design / installing engineer. See Appendix 2: Emergency lighting, for further information.</p>
<b>Escape Route</b>	Not applicable due to means of escape arrangements via suitable escape window openings. See Appendices 4 and 5 referring to escape windows and window security respectively.
<b>Fire Doors</b>	<p>The fitting of fire doors is not required.</p> <p>Solid timber and panelled interior doors are acceptable as long as they are well fitted and of sound and solid construction.</p>

## Chapter 3: Typical shared house accommodation layouts PLAN 2

SCHEDULE TO PLAN No. 2: Typical pre-1919 two storey shared house with stairway off living room and shared cooking facilities (Alternative scheme to Plan 1)	
<b>Security of Doors</b>	<p>Locks on final exit doors and any bedrooms must be capable of being opened from the inside without the use of keys. In addition, to improve the overall security of the property and to comply with advice from the Association of British Insurers, it is recommended that BS8621 mortice locks fitted with thumb turns are used on the exit doors; this is a mortice lock (sometimes called a sashlock) which conforms to British Standard BS8621 fitted with a 6 pin cylinder thumb turn.</p> <p>The final exit doors should also be solid and at least 44mm (1<sup>3</sup>/<sub>4</sub>" ) thick and certified to British Standard PAS 24-1 'Doors of Enhanced Security'. For more information about BS8621 mortice thumb turn locks and PAS 24-1 doors please refer to the relevant section in Appendix 7: Door security.</p>
<b>Fire Blankets</b>	A fire blanket to BS 6575 (or equivalent) is to be provided in the kitchen. The blanket must be mounted on the wall 1.5m high adjacent to an exit door away from the cooking facility.
<b>Extinguishers</b>	For further guidance see page 11.
<b>Other recommendations</b>	<p>Polystyrene ceiling tiles <b>should not</b> be used within the premises.</p> <p>Heaters – portable heaters using gas cylinders or flammable liquids <b>should not</b> be used or stored in the premises.</p>

PLAN 3

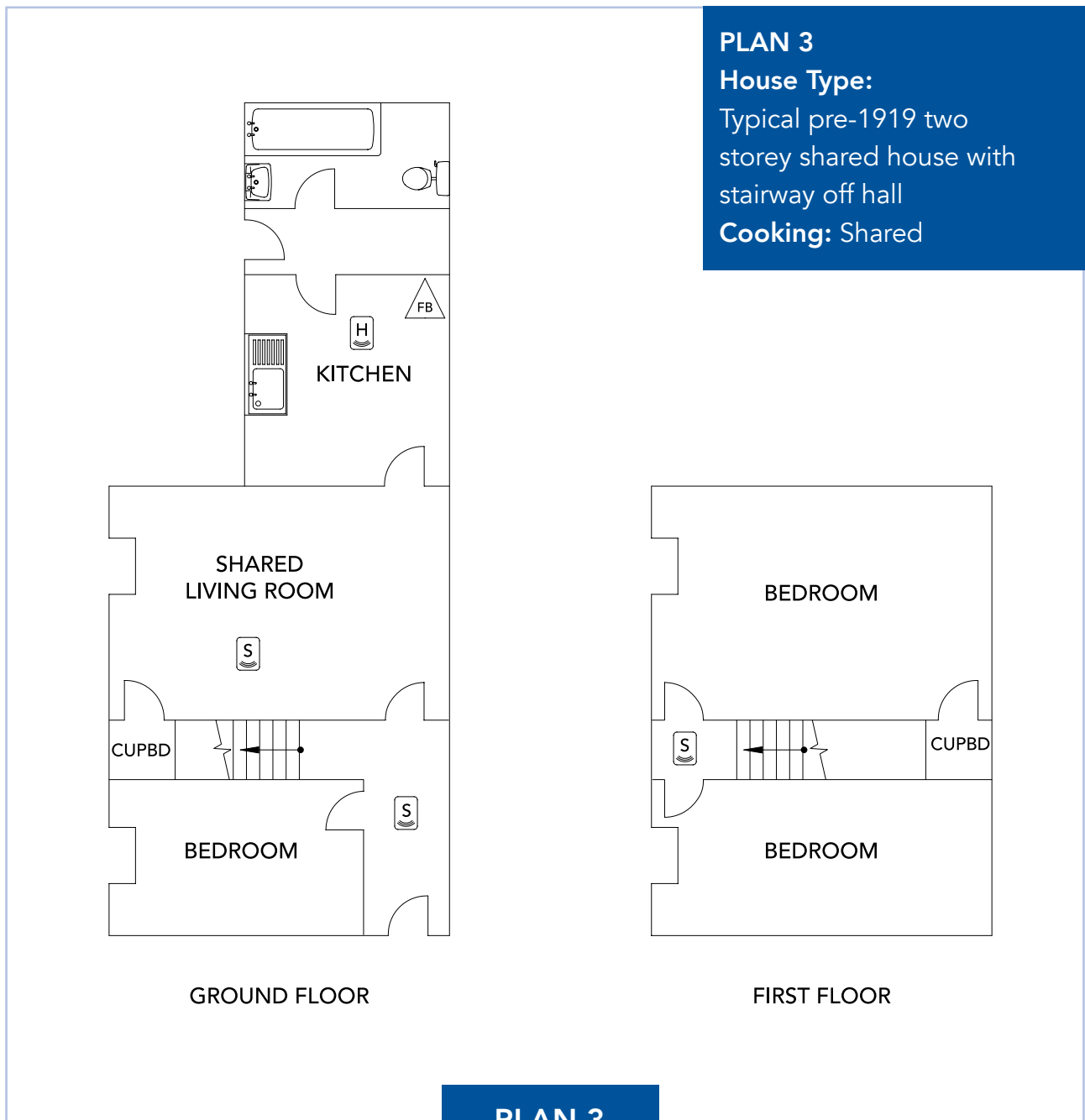

The layout of this type of house can be safer than the one where the exit route is through the living room.



Chapter 3: Typical shared house accommodation layouts  
**PLAN 3**

<b>SCHEDULE TO PLAN No. 3: Typical pre-1919 two storey shared house with stairway off hall and shared cooking facilities</b>	
<b>Detection/Warning</b>	<p>A system of mains powered automatic smoke detectors with battery back up, to achieve a Grade D system in accordance with the current BS 5839 Part 6 (or equivalent), must be installed.</p> <p>In kitchens a heat detector, rather than a smoke detector, must be installed.</p> <p>All detectors must be interlinked, so that if one detector is triggered the alarm sounds in each and every alarm location.</p> <p>There are two types of smoke detector, 'ionisation' and 'optical'. Optical detectors are better in most situations, because they are less likely to give false alarms. See Appendix 1: Automatic fire detection and alarm systems for further details.</p>
<b>Control Panel</b>	<p>Not required</p>
<b>Emergency Lighting</b>	<p>Subject to a fire risk assessment emergency lighting should not be necessary, provided that the escape route is not long or complex and there is effective artificial or borrowed lighting.</p> <p>Where emergency lighting is considered to be necessary, it should be provided in accordance with the current BS 5266 Part 1 (or equivalent) to cover the protected escape route.</p> <p>The location of light fittings is to be determined by the design / installing engineer. See Appendix 2: Emergency lighting for further information.</p>
<b>Escape Route</b>	<p>Not applicable due to means of escape arrangements via suitable escape window openings. See Appendices 4 and 5 referring to escape windows and window security respectively.</p>

## Chapter 3: Typical shared house accommodation layouts PLAN 3

SCHEDULE TO PLAN No. 3: Typical pre-1919 two shared storey house with stairway off hall and shared cooking facilities	
<b>Fire Doors</b>	<p>The fitting of fire doors is not required.</p> <p>Solid timber and panelled interior doors are acceptable as long as they are well fitted and of sound and solid construction.</p>
<b>Security of Doors</b>	<p>Locks on final exit doors and any bedrooms must be capable of being opened from the inside without the use of keys. In addition, to improve the overall security of the property and to comply with advice from the Association of British Insurers, it is recommended that BS8621 mortice locks fitted with thumb turns are used on the exit doors; this is a mortice lock (sometimes called a sashlock) which conforms to British Standard BS8621 fitted with a 6 pin cylinder thumb turn.</p> <p>The final exit doors should also be solid and at least 44mm (1<sup>3</sup>/<sub>4</sub>" ) thick and certified to British Standard PAS 24-1 'Doors of Enhanced Security'. For more information about BS8621 mortice thumb turn locks and PAS 24-1 doors please refer to the relevant section in Appendix 7: Door security.</p>
<b>Fire Blankets</b>	<p>A fire blanket to BS 6575 (or equivalent) is to be provided in the kitchen. The blanket must be mounted on the wall 1.5m high adjacent to an exit door away from the cooking facility.</p>
<b>Extinguishers</b>	<p>For further guidance see page 11.</p>
<b>Other recommendations</b>	<p>Polystyrene ceiling tiles <b>should not</b> be used within the premises.</p> <p>Heaters – portable heaters using gas cylinders or flammable liquids <b>should not</b> be used or stored in the premises.</p>

PLAN 4

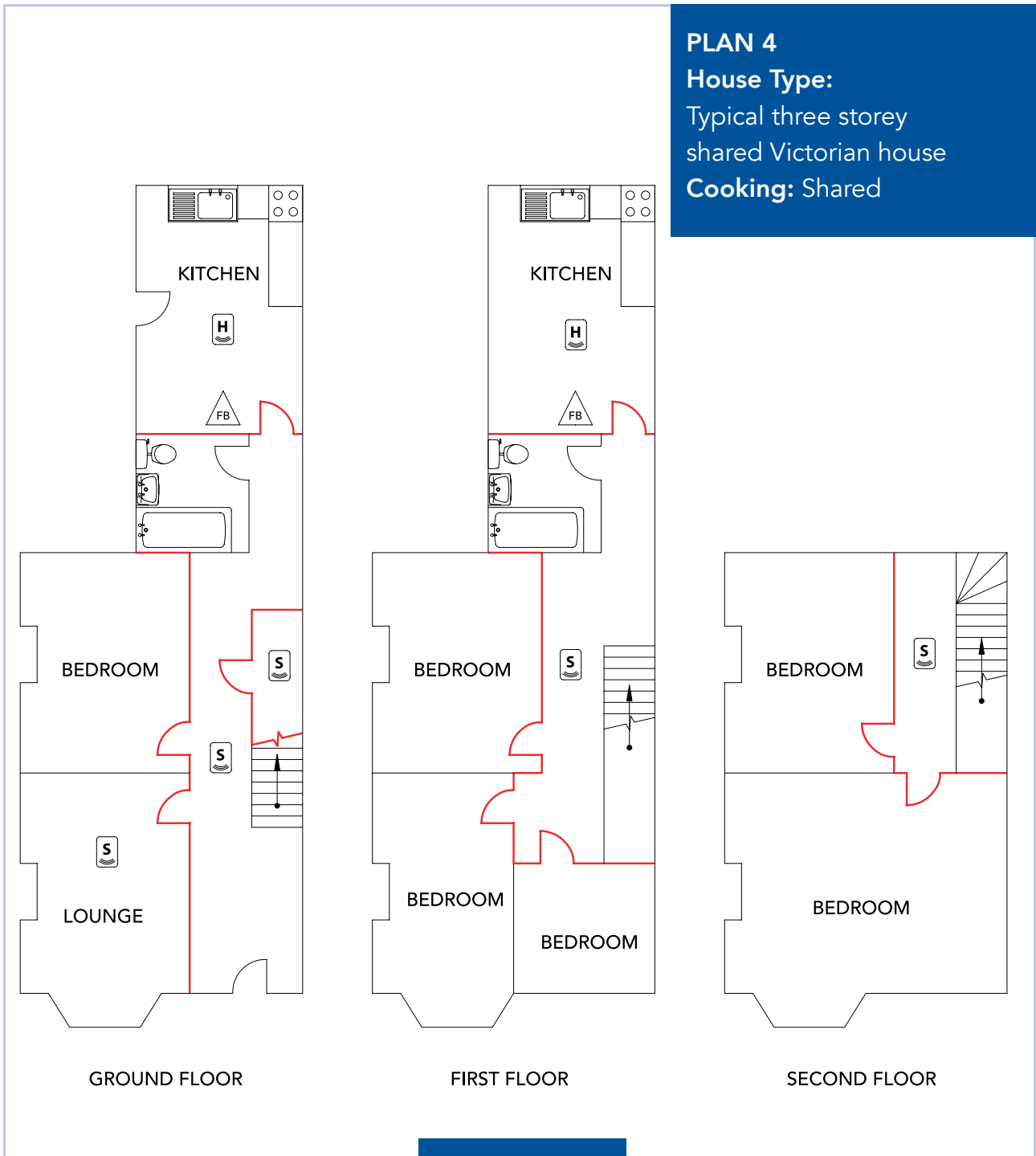

The above plan shows the ideal situation, however in low risk properties (please refer to Chapter 2) existing doors opening onto the escape route are acceptable providing that they are of sound and solid construction, and are close fitting and self closing.

It may also be possible to accept existing walls and partitions if 20 minutes fire resistance can be achieved.

## Chapter 3: Typical shared house accommodation layouts PLAN 4

<b>SCHEDULE TO PLAN No. 4: Typical three storey shared Victorian house with shared cooking facilities</b>	
<b>Detection/Warning</b>	<p>A system of mains powered automatic smoke detectors with battery back up, to achieve a Grade D system in accordance with the current BS 5839 Part 6 (or equivalent), must be installed.</p> <p>In kitchens a heat detector, rather than a smoke detector, must be installed.</p> <p>All detectors must be interlinked, so that if one detector is triggered the alarm sounds in each and every alarm location.</p> <p>There are two types of smoke detector, 'ionisation' and 'optical'. Optical detectors are better in most situations, because they are less likely to give false alarms. See Appendix 1: Automatic fire detection and alarm systems for further details.</p>
<b>Control Panel</b>	Not required
<b>Emergency Lighting</b>	<p>Subject to a fire risk assessment emergency lighting should not be necessary, provided that the escape route is not long or complex and there is effective artificial or borrowed lighting.</p> <p>Where emergency lighting is considered to be necessary, it should be provided in accordance with the current BS 5266 Part 1 (or equivalent) to cover the protected escape route.</p> <p>The location of light fittings is to be determined by the design / installing engineer. See Appendix 2 for further information.</p>
<b>Protected Route</b>	<p>The protected escape route is designed to allow for tenants from all parts of the building to reach the outside without passing through a higher fire risk area. The protected route <b>MUST</b> be kept clear of obstructions and combustible materials. The walls and ceilings of all parts of the protected route <b>MUST</b> be free of highly flammable materials i.e. polystyrene tiles or heavy flock wallpaper.</p> <p>Subject to the findings of a fire risk assessment, electric meters within the protected route may need to be housed within a fire-resisting cupboard. Where gas meters are contained within the protected route see Appendix 9.</p>

**SCHEDULE TO PLAN No. 4: Typical three storey shared Victorian house  
with shared cooking facilities**

<b>Protected Route</b> <i>(continued)</i>	See Appendix 3 for further information regarding fire resisting construction of walls/partitions.
<b>Fire Doors</b>	A fire door (FD30) must be installed in each doorway leading onto the protected escape route except bathrooms/ WCs containing no fire risk. See Appendix 6 on fire doors.
<b>Security of Doors</b>	<p>Locks on final exit doors and any bedrooms must be capable of being opened from the inside without the use of keys. In addition, to improve the overall security of the property and to comply with advice from the Association of British Insurers, it is recommended that BS8621 mortice locks fitted with thumb turns are used on these doors; this is a mortice lock (sometimes called a sashlock) which conforms to British Standard BS8621 fitted with a 6 pin cylinder thumb turn.</p> <p>The final exit doors should also be solid and at least 44mm (1<sup>3</sup>/<sub>4</sub>" ) thick and certified to British Standard PAS 24-1 'Doors of Enhanced Security'. For more information about BS8621 mortice thumb turn locks and PAS 24-1 doors please refer to the relevant section in Appendix 7: Door security.</p>
<b>Fire Separation</b>	Floor/ ceiling construction including the under-stairs store and cellars must achieve a nominal 30 minute fire resistance. See Appendix 8 on how to achieve this.
<b>Fire Blankets</b>	A fire blanket to BS 6575 (or equivalent) is to be provided in each kitchen. The blanket must be mounted on the wall 1.5m high adjacent to an exit door away from the cooking facility.
<b>Extinguishers</b>	For further guidance see page 11.
<b>Other recommendations</b>	<p>Polystyrene ceiling tiles <b>should not</b> be used within the premises.</p> <p>Heaters – portable heaters using gas cylinders or flammable liquids <b>should not</b> be used or stored in the premises.</p>

# Chapter 4: Typical bedsit accommodation layouts

## PLAN 5

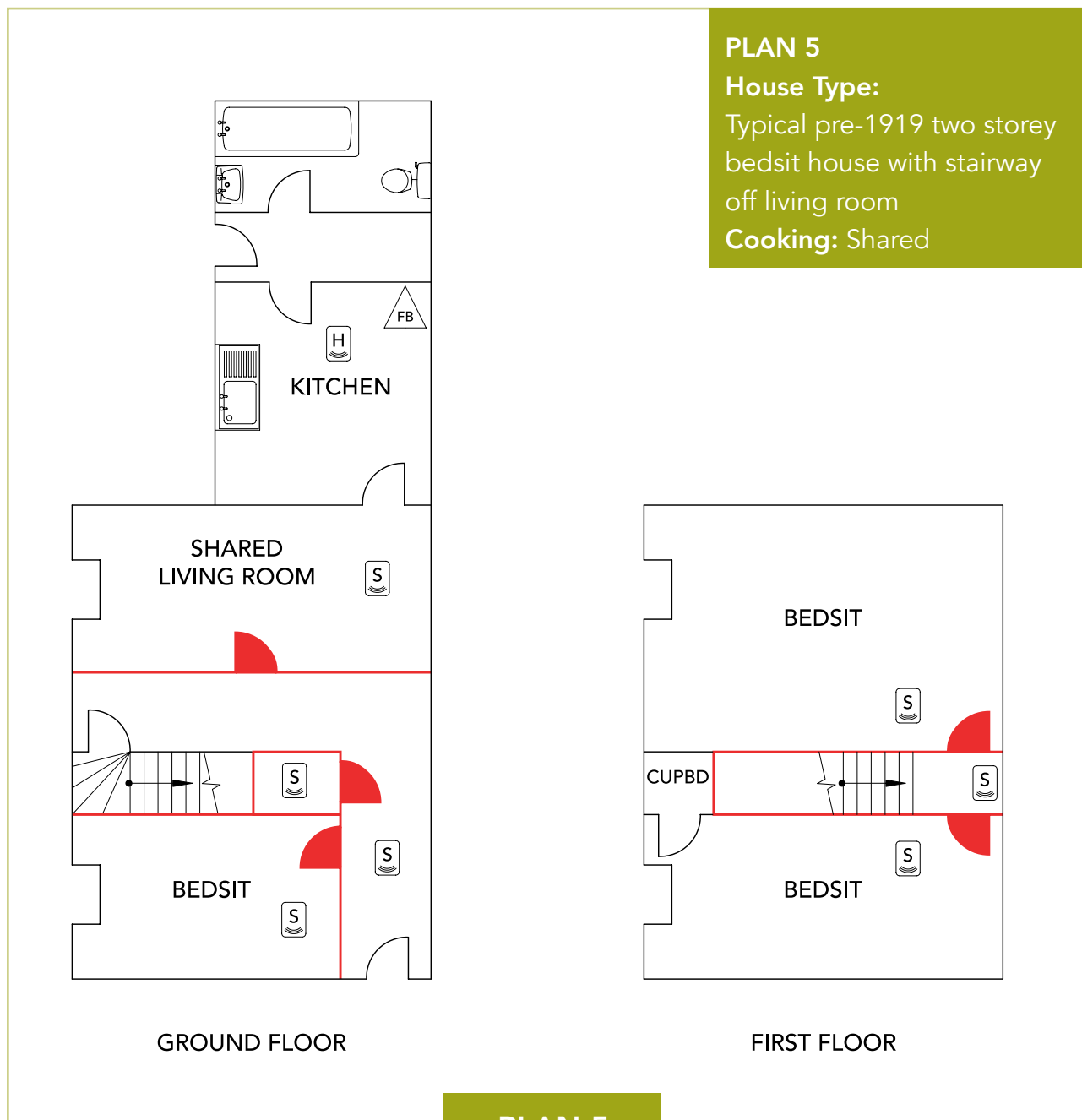

The above plan show precautions required for bedsit accommodation with shared cooking facilities.

By providing a protected escape route from all habitable rooms and putting a detector/sounder in every room, anyone upstairs or indeed anywhere in the house will quickly be alerted if there is a fire and should be able to get down the stairs quickly to safety through the front door.

The escape route needs to be protected by half hour fire resisting partitions and fire doors.

## Chapter 4: Typical bedsit accommodation layouts PLAN 5

<b>SCHEDULE TO PLAN No. 5: Typical pre-1919 two storey bedsit house with stairway off living room</b>	
<b>Detection/Warning</b>	<p>A system of mains powered automatic smoke detectors with battery back up, to achieve a Grade D system in accordance with the current BS 5839 Part 6 (or equivalent), must be installed. Detectors must be sited in all areas containing a fire risk.</p> <p>In kitchens a heat detector, rather than a smoke detector, must be installed.</p> <p>All detectors must be interlinked, so that if one detector is triggered the alarm sounds in each and every alarm location.</p> <p>There are two types of smoke detector, 'ionisation' and 'optical'. Optical detectors are better in most situations, because they are less likely to give false alarms. See Appendix 1: Automatic fire detection and alarm systems for further details.</p>
<b>Control Panel</b>	Not required
<b>Emergency Lighting</b>	<p>Subject to a fire risk assessment emergency lighting should not be necessary, provided that the escape route is not long or complex and there is effective artificial or borrowed lighting.</p> <p>Where emergency lighting is considered to be necessary, it should be provided in accordance with the current BS 5266 Part 1 (or equivalent) to cover the protected escape route.</p> <p>The location of light fittings is to be determined by the design / installing engineer. See Appendix 2 for further information.</p>
<b>Protected Route</b>	<p>The protected escape route is designed to allow for tenants from all parts of the building to reach the outside without passing through a higher fire risk area. The protected route <b>MUST</b> be kept clear of obstructions and combustible materials. The walls and ceilings of all parts of the protected route <b>MUST</b> be free of highly flammable materials i.e. polystyrene tiles or heavy flock wallpaper.</p> <p>Subject to the findings of a fire risk assessment, electric meters within the protected route may need to be housed within a fire-resisting cupboard. Where gas meters are contained within the protected route see Appendix 9.</p>

## Chapter 4: Typical bedsit accommodation layouts

### PLAN 5

SCHEDULE TO PLAN No. 5: Typical pre-1919 two storey bedsit house with stairway off living room	
<b>Protected Route</b> <i>(continued)</i>	See Appendix 3 for further information regarding fire resisting construction of walls/partitions.
<b>Fire Doors</b>	A fire door (FD30S) must be installed in each doorway leading onto the protected escape route except bathrooms/ WCs containing no fire risk. See Appendix 6 on fire doors.
<b>Security of Doors</b>	<p>Locks on final exit doors and any bedrooms must be capable of being opened from the inside without the use of keys. In addition, to improve the overall security of the property and to comply with advice from the Association of British Insurers, it is recommended that BS8621 mortice locks fitted with thumb turns are used on these doors; this is a mortice lock (sometimes called a sashlock) which conforms to British Standard BS8621 fitted with a 6 pin cylinder thumb turn.</p> <p>The final exit doors should also be solid and at least 44mm (1¾") thick and certified to British Standard PAS 24-1 'Doors of Enhanced Security'. For more information about BS8621 mortice thumb turn locks and PAS 24-1 doors please refer to the relevant section in Appendix 7: Door security.</p>
<b>Fire Separation</b>	Floor/ ceiling construction including the under-stairs store and cellars must achieve a nominal 30 minute fire resistance. See Appendix 8 on how to achieve this.
<b>Fire Blankets</b>	A fire blanket to BS 6575 (or equivalent) is to be provided in each kitchen. The blanket must be mounted on the wall 1.5m high adjacent to an exit door away from the cooking facility.
<b>Extinguishers</b>	For further guidance see page 11.
<b>Other recommendations</b>	<p>Polystyrene ceiling tiles <b>should not</b> be used within the premises.</p> <p>Heaters – portable heaters using gas cylinders or flammable liquids <b>should not</b> be used or stored in the premises.</p>



## Chapter 4: Typical bedsit accommodation layouts

### PLAN 6

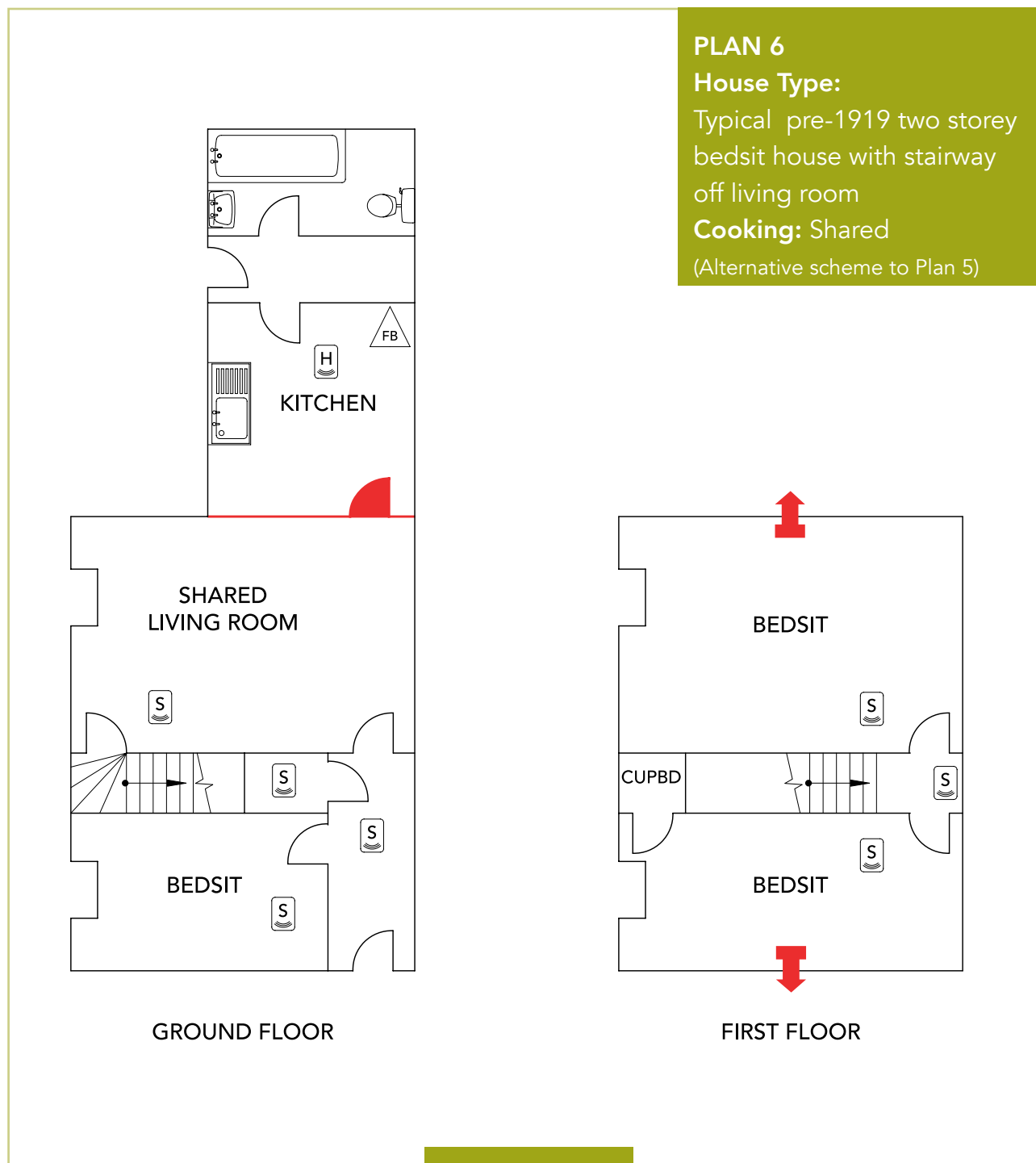

Alternatively, to the preferred option of Plan 5, means of escape can be achieved by separating the kitchen with a self closing fire door and putting a detector / sounder in every room.

In this scheme, escape window openings must be provided from the first floor habitable rooms, to provide a secondary means of escape in the event that the primary escape route is compromised.

## Chapter 4: Typical bedsit accommodation layouts PLAN 6

<b>SCHEDULE TO PLAN No. 6: Typical pre-1919 two storey bedsit house with stairway off living room (Alternative scheme to Plan 5)</b>	
<b>Detection/Warning</b>	<p>A system of mains powered automatic smoke detectors with battery back up, to achieve a Grade D system in accordance with the current BS 5839 Part 6 (or equivalent), must be installed. Detectors must be sited in all areas containing a fire risk.</p> <p>In kitchens a heat detector, rather than a smoke detector, must be installed.</p> <p>All detectors must be interlinked, so that if one detector is triggered the alarm sounds in each and every alarm location.</p> <p>There are two types of smoke detector, 'ionisation' and 'optical'. Optical detectors are better in most situations, because they are less likely to give false alarms. See Appendix 1: Automatic fire detection and alarm systems for further details.</p>
<b>Control Panel</b>	Not required
<b>Emergency Lighting</b>	<p>Subject to a fire risk assessment emergency lighting should not be necessary, provided that the escape route is not long or complex and there is effective artificial or borrowed lighting.</p> <p>Where emergency lighting is considered to be necessary, it should be provided in accordance with the current BS 5266 Part 1 (or equivalent) to cover the protected escape route.</p> <p>The location of light fittings is to be determined by the design / installing engineer. See Appendix 2 for further information.</p>
<b>Protected Route</b>	Not applicable due to means of escape arrangements via suitable escape window openings. See Appendices 4 and 5 referring to escape windows and window security respectively.
<b>Fire Doors</b>	A fire door (FD30S) must be installed to the doorway between the shared living room and kitchen. See Appendix 6 on fire doors.

## Chapter 4: Typical bedsit accommodation layouts

### PLAN 6

#### SCHEDULE TO PLAN No. 6: Typical pre-1919 two storey bedsit house with stairway off living room (Alternative scheme to Plan 5)

<b>Security of Doors</b>	<p>Locks on final exit doors and any bedrooms must be capable of being opened from the inside without the use of keys. In addition, to improve the overall security of the property and to comply with advice from the Association of British Insurers, it is recommended that BS8621 mortice locks fitted with thumb turns are used on these doors; this is a mortice lock (sometimes called a sashlock) which conforms to British Standard BS8621 fitted with a 6 pin cylinder thumb turn.</p> <p>The final exit doors should also be solid and at least 44mm (1<sup>3</sup>/<sub>4</sub>"") thick and certified to British Standard PAS 24-1 'Doors of Enhanced Security'. For more information about BS8621 mortice thumb turn locks and PAS 24-1 doors please refer to the relevant section in Appendix 7: Door security.</p>
<b>Fire Separation</b>	<p>The wall between the kitchen and shared living room must provide 30 minutes fire resistance. See Appendix 3: Fire resistance of walls and partitions.</p> <p>Floor/ ceiling construction including the under-stairs store and cellars must achieve a nominal 30 minute fire resistance. See Appendix 8 on how to achieve this.</p>
<b>Fire Blankets</b>	<p>A fire blanket to BS 6575 (or equivalent) is to be provided in each kitchen. The blanket must be mounted on the wall 1.5m high adjacent to an exit door away from the cooking facility.</p>
<b>Extinguishers</b>	<p>For further guidance see page 11.</p>
<b>Other recommendations</b>	<p>Polystyrene ceiling tiles <b>should not</b> be used within the premises.</p> <p>Heaters – portable heaters using gas cylinders or flammable liquids <b>should not</b> be used or stored in the premises.</p>

## Chapter 4: Typical bedsit accommodation layouts PLAN 7



As soon as cooking in individual lets is introduced the fire precautions involved become greater. The escape route needs to be protected by half-hour fire resisting partitions and fire doors together with a mixed fire detection and warning system.

## Chapter 4: Typical bedsit accommodation layouts PLAN 7

<b>SCHEDULE TO PLAN No. 7: Typical two storey bedsit type Victorian house with cooking facilities in lets</b>	
<b>Detection/Warning</b>	<p>A mains powered fire detection and warning system must be provided. The main system shall provide heat detectors in individual lets and smoke detectors in common areas and any storerooms/cellars (interlinked system).</p> <p>To provide an early warning to occupiers of a fire occurring within their rooms, single point smoke alarms are also required. These detectors are not interlinked between rooms.</p> <p>Both systems to conform to the current Grade D of BS 5839 Part 6 (or equivalent).</p> <p>There are two types of smoke detector, 'ionisation' and 'optical'. Optical detectors are better in most situations, because they are less likely to give false alarms. See Appendix 1: Automatic fire detection and alarm systems, for further details.</p>
<b>Control Panel</b>	Not required
<b>Emergency Lighting</b>	<p>Subject to a fire risk assessment emergency lighting should not be necessary, provided that the escape route is not long or complex and there is effective artificial or borrowed lighting.</p> <p>Where emergency lighting is considered to be necessary, it should be provided in accordance with the current BS 5266 Part 1 (or equivalent) to cover the protected escape route.</p> <p>The location of light fittings is to be determined by the design / installing engineer. See Appendix 2: Emergency lighting, for further information.</p>
<b>Protected Route</b>	<p>The protected escape route is designed to allow for tenants from all parts of the building to reach the outside without passing through a higher fire risk area. The protected route <b>MUST</b> be kept clear of obstructions and combustible materials. The walls and ceilings of all parts of the protected route <b>MUST</b> be free of highly flammable materials i.e. polystyrene tiles or heavy flock wallpaper.</p> <p>Subject to the findings of a fire risk assessment, electric meters within the protected route may need to be housed within a fire-resisting cupboard. Where gas meters are contained within the protected route see Appendix 9.</p>

## Chapter 4: Typical bedsit accommodation layouts

### PLAN 7

<b>SCHEDULE TO PLAN No. 7: Typical two storey bedsit type Victorian house with cooking facilities in lets</b>	
<b>Protected Route</b> <i>(continued)</i>	See Appendix 3 for further information regarding fire resisting construction of walls/partitions.
<b>Fire Doors</b>	A fire door (FD30S) must be installed in each doorway leading onto the protected escape route except bathrooms / WCs containing no fire risk. See Appendix 6 on fire doors.
<b>Security of Doors</b>	<p>Locks on individual bedsit and final exit doors must be capable of being opened from the inside without the use of keys. In addition, to improve the overall security of the property and to comply with advice from the Association of British Insurers, it is recommended that BS8621 mortice locks fitted with thumb turns are used on these doors; this is a mortice lock (sometimes called a sashlock) which conforms to British Standard BS8621 fitted with a 6 pin cylinder thumb turn.</p> <p>The final exit doors should also be solid and at least 44mm (1<sup>3</sup>/<sub>4</sub>"") thick and certified to British Standard PAS 24-1 'Doors of Enhanced Security'. For more information about BS8621 mortice thumb turn locks and PAS 24-1 doors please refer to the relevant section in Appendix 7: Door security.</p>
<b>Fire Separation</b>	Floor/ ceiling construction including the under-stairs store and cellars must achieve a nominal 30 minute fire resistance. See Appendix 8 on how to achieve this.
<b>Fire Blankets</b>	A fire blanket to BS 6575 (or equivalent) is to be provided in each let. The blanket must be mounted on the wall 1.5m high adjacent to an exit door away from the cooking facility.
<b>Extinguishers</b>	For further guidance see page 11.
<b>Other recommendations</b>	<p>Polystyrene ceiling tiles <b>should not</b> be used within the premises.</p> <p>Heaters – portable heaters using gas cylinders or flammable liquids <b>should not</b> be used or stored in the premises.</p>

## Chapter 4: Typical bedsit accommodation layouts PLAN 8

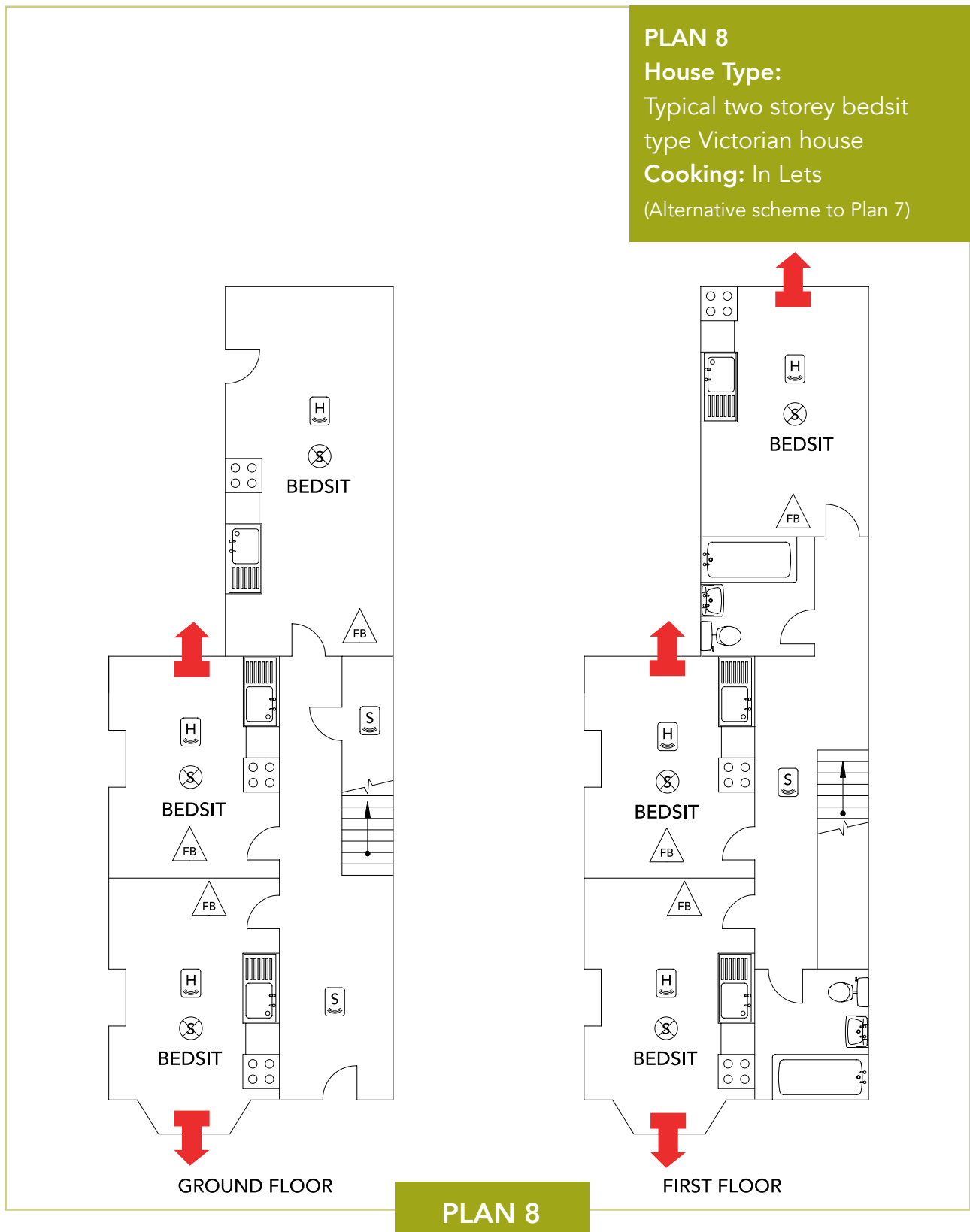

Alternatively, to the preferred option of Plan 7, means of escape can be achieved by putting in a mixed fire detection and warning system and providing escape window openings from all bedsit rooms to provide a secondary means of escape, in the event that the primary escape route is compromised.

**Chapter 4: Typical bedsit accommodation layouts**  
**PLAN 8**

<b>SCHEDULE TO PLAN No. 8: Typical two storey bedsit type Victorian house with cooking facilities in lets (Alternative scheme to Plan 7)</b>	
<b>Detection/Warning</b>	<p>A mains powered fire detection and warning system must be provided. The main system shall provide heat detectors in individual lets and smoke detectors in common areas and any storerooms/cellars (interlinked system).</p> <p>To provide an early warning to occupiers of a fire occurring within their rooms, single point smoke alarms are also required. These detectors are not interlinked between rooms.</p> <p>Both systems to conform to the current Grade D of BS 5839 Part 6 (or equivalent).</p> <p>There are two types of smoke detector, 'ionisation' and 'optical'. Optical detectors are better in most situations, because they are less likely to give false alarms. See Appendix 1: Automatic fire detection and alarm systems, for further details.</p>
<b>Control Panel</b>	
<b>Emergency Lighting</b>	<p>Subject to a fire risk assessment emergency lighting should not be necessary, provided that the escape route is not long or complex and there is effective artificial or borrowed lighting.</p> <p>Where emergency lighting is considered to be necessary, it should be provided in accordance with the current BS 5266 Part 1 (or equivalent) to cover the protected escape route.</p> <p>The location of light fittings is to be determined by the design / installing engineer. See Appendix 2 for further information.</p>
<b>Escape Route</b>	<p>The escape route is designed to allow for tenants from all parts of the building to reach the outside without passing through a higher fire risk area. The escape route MUST be kept clear of obstructions and combustible materials. The walls and ceilings of all parts of the protected route MUST be free of highly flammable materials i.e. polystyrene tiles or heavy flock wallpaper.</p>



## Chapter 4: Typical bedsit accommodation layouts PLAN 8

### SCHEDULE TO PLAN No. 8: Typical two storey bedsit type Victorian house with cooking facilities in lets (Alternative scheme to Plan 7)

<b>Fire Doors</b>	<p>The fitting of fire doors is not required.</p> <p>Solid timber and panelled interior doors are acceptable as long as they are well fitted and of sound and solid construction.</p>
<b>Security of Doors</b>	<p>Locks on individual bedsit and final exit doors must be capable of being opened from the inside without the use of keys. In addition, to improve the overall security of the property and to comply with advice from the Association of British Insurers, it is recommended that BS8621 mortice locks fitted with thumb turns are used on the exit doors; this is a mortice lock (sometimes called a sashlock) which conforms to British Standard BS8621 fitted with a 6 pin cylinder thumb turn.</p> <p>The final exit doors should also be solid and at least 44mm (1<sup>3</sup>/<sub>4</sub>" ) thick and certified to British Standard PAS 24-1 'Doors of Enhanced Security'. For more information about BS8621 mortice thumb turn locks and PAS 24-1 doors please refer to the relevant section in Appendix 7: Door security.</p>
<b>Fire Windows</b>	<p>Escape windows should be designed, constructed and installed in accordance with the standards detailed in Appendices 4 and 5.</p>
<b>Fire Blankets</b>	<p>A fire blanket to BS 6575 (or equivalent) is to be provided in each let. The blanket must be mounted on the wall 1.5m high adjacent to an exit door away from the cooking facility.</p>
<b>Extinguishers</b>	<p>For further guidance see page 11.</p>
<b>Other recommendations</b>	<p>Polystyrene ceiling tiles <b>should not</b> be used within the premises.</p> <p>Heaters – portable heaters using gas cylinders or flammable liquids <b>should not</b> be used or stored in the premises.</p>

# Chapter 4: Typical bedsit accommodation layouts

## PLAN 9

### PLAN 9

House Type:

Typical three storey bedsit type Victorian house

Cooking: Shared



### PLAN 9

In three storey bedsit type properties, a fire control panel is required as part of the fire detection / warning system.

## Chapter 4: Typical bedsit accommodation layouts PLAN 9

### SCHEDULE TO PLAN No. 9: Typical three storey bedsit type Victorian house with shared cooking facilities

<b>Detection/Warning</b>	<p>Fire warning and detection system to be provided conforming to GRADE A of the current BS 5859 Part 6 (or equivalent).</p> <p>Automatic detection must provide LD2 coverage.</p> <p>In kitchens, a heat detector rather than a smoke detector must be installed.</p> <p>There are two types of smoke detector, 'ionisation' and 'optical'. Optical detectors are better in most situations, because they are less likely to give false alarms. See Appendix 1: Automatic fire detection and alarm systems, for further details.</p>
<b>Control Panel</b>	<p>To be sited close to the normal entrance to the dwelling.</p>
<b>Emergency Lighting</b>	<p>Subject to a fire risk assessment emergency lighting should not be necessary, provided that the escape route is not long or complex and there is effective artificial or borrowed lighting.</p> <p>Where emergency lighting is considered to be necessary, it should be provided in accordance with the current BS 5266 Part 1 (or equivalent) to cover the protected escape route.</p> <p>The location of light fittings is to be determined by the design / installing engineer. See Appendix 2 for further information.</p>
<b>Protected Route</b>	<p>The protected escape route is designed to allow for tenants from all parts of the building to reach the outside without passing through a higher fire risk area. The protected route <b>MUST</b> be kept clear of obstructions and combustible materials. The walls and ceilings of all parts of the protected route <b>MUST</b> be free of highly flammable materials i.e. polystyrene tiles or heavy flock wallpaper.</p> <p>Subject to the findings of a fire risk assessment, electric meters within the protected route may need to be housed within a fire-resisting cupboard. Where gas meters are contained within the protected route see Appendix 9.</p>

## Chapter 4: Typical bedsit accommodation layouts

### PLAN 9

<b>SCHEDULE TO PLAN No. 9: Typical three storey bedsit type Victorian house with shared cooking facilities</b>	
<b>Protected Route</b> <i>(continued)</i>	See Appendix 3 for further information regarding fire resisting construction of walls/partitions.
<b>Fire Doors</b>	A fire door (FS30S) must be installed in each doorway leading onto the protected escape route except bathrooms / WCs containing no fire risk. See Appendix 6 on fire doors.
<b>Security of Doors</b>	<p>Locks on individual bedsit and final exit doors must be capable of being opened from the inside without the use of keys. In addition, to improve the overall security of the property and to comply with advice from the Association of British Insurers, it is recommended that BS8621 mortice locks fitted with thumb turns are used on the exit doors; this is a mortice lock (sometimes called a sashlock) which conforms to British Standard BS8621 fitted with a 6 pin cylinder thumb turn.</p> <p>The final exit doors should also be solid and at least 44mm (1<sup>3</sup>/<sub>4</sub>" ) thick and certified to British Standard PAS 24-1 'Doors of Enhanced Security'. For more information about BS8621 mortice thumb turn locks and PAS 24-1 doors please refer to the relevant section in Appendix 7: Door security.</p>
<b>Fire Separation</b>	Floor/ ceiling construction including the under-stairs store and cellars must achieve a nominal 30 minute fire resistance. See Appendix 8 on how to achieve this.
<b>Fire Blankets</b>	A fire blanket to BS 6575 (or equivalent) is to be provided in each kitchen. The blanket must be mounted on the wall 1.5m high adjacent to an exit door away from the cooking facility.
<b>Extinguishers</b>	For further guidance see page 11.
<b>Other recommendations</b>	<p>Polystyrene ceiling tiles <b>should not</b> be used within the premises.</p> <p>Heaters – portable heaters using gas cylinders or flammable liquids <b>should not</b> be used or stored in the premises.</p>

# Chapter 4: Typical bedsit accommodation layouts

## PLAN 10

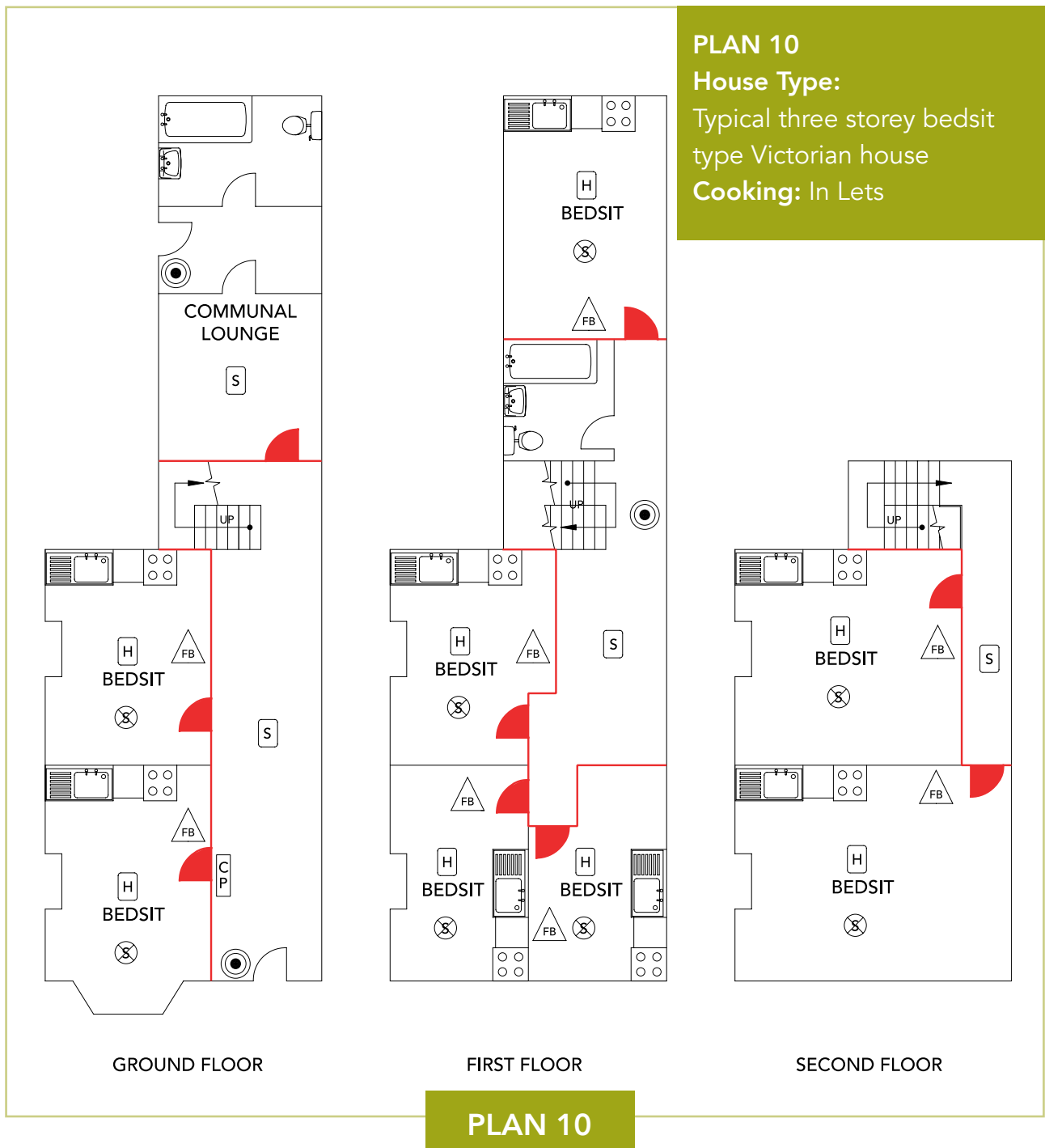

In three storey bedsit type accommodation with cooking in lets, additional fire protection will be required.

## Chapter 4: Typical bedsit accommodation layouts PLAN 10

<b>SCHEDULE TO PLAN No. 10 Typical three storey bedsit type Victorian house with cooking facilities in lets</b>	
<b>Detection/Warning</b>	<p>A mixed fire detection and warning system conforming to the current BS 5839 Part 6 (or equivalent) must be provided, comprising of GRADE A (main system) and GRADE D (Single point smoke alarms). The main system must provide LD2 coverage.</p> <p>The single point smoke alarms are to be sited in each let. These detectors are not interlinked between rooms.</p> <p>There are two types of smoke detector, 'ionisation' and 'optical'. Optical detectors are better in most situations, because they are less likely to give false alarms. See Appendix 1: Automatic fire detection and alarm systems, for further details.</p>
<b>Control Panel</b>	To be sited close to the normal entrance to the dwelling.
<b>Emergency Lighting</b>	<p>Subject to a fire risk assessment emergency lighting should not be necessary, provided that the escape route is not long or complex and there is effective artificial or borrowed lighting.</p> <p>Where emergency lighting is considered to be necessary, it should be provided in accordance with the current BS 5266 Part 1 (or equivalent) to cover the protected escape route.</p> <p>The location of light fittings is to be determined by the design / installing engineer. See Appendix 2 for further information.</p>
<b>Protected Route</b>	<p>The protected route is designed to allow for tenants from all parts of the building to reach the outside without passing through a higher fire risk area. The protected route MUST be kept clear of obstructions and combustible materials. The walls and ceilings of all parts of the protected route MUST be free of highly flammable materials i.e. polystyrene tiles or heavy flock wallpaper.</p> <p>Subject to the findings of a fire risk assessment, electric meters within the protected route may need to be housed within a fire-resisting cupboard. Where gas meters are contained within the protected route see Appendix 9.</p>

## Chapter 4: Typical bedsit accommodation layouts PLAN 10

<b>SCHEDULE TO PLAN No. 10 Typical three storey bedsit type Victorian house with cooking facilities in lets</b>	
<b>Protected Route</b> <i>(continued)</i>	See Appendix 3 for further information regarding fire resisting construction of walls/partitions.
<b>Fire Doors</b>	A fire door (FD30S) must be installed in each doorway leading onto the protected escape route except bathrooms/wc containing no fire risk. See Appendix 6 on fire doors.
<b>Security of Doors</b>	<p>Locks on individual besits and final exit doors must be capable of being opened from the inside without the use of keys. In addition, to improve the overall security of the property and to comply with advice from the Association of British Insurers, it is recommended that BS8621 mortice locks fitted with thumb turns are used on the exit doors; this is a mortice lock (sometimes called a sashlock) which conforms to British Standard BS8621 fitted with a 6 pin cylinder thumb turn.</p> <p>The final exit doors should also be solid and at least 44mm (1<sup>3</sup>/<sub>4</sub>"") thick and certified to British Standard PAS 24-1 'Doors of Enhanced Security'. For more information about BS8621 mortice thumb turn locks and PAS 24-1 doors please refer to the relevant section in Appendix 7: Door security.</p>
<b>Fire Separation</b>	Floor/ceiling construction including the under-stairs store and cellars must achieve 30 minutes fire resistance. See Appendix 8 on how to achieve this.
<b>Fire Blankets</b>	A fire blanket to BS 6575 (or equivalent) is to be provided in each let. The blanket must be mounted on the wall 1.5m high adjacent to an exit door away from the cooking facility.
<b>Extinguishers</b>	For further guidance see page 11.
<b>Other recommendations</b>	<p>Polystyrene ceiling tiles <b>should not</b> be used within the premises.</p> <p>Heaters – portable heaters using gas cylinders or flammable liquids <b>should not</b> be used or stored in the premises.</p>

# Chapter 5: Typical layouts of buildings converted into flats

## PLAN 11

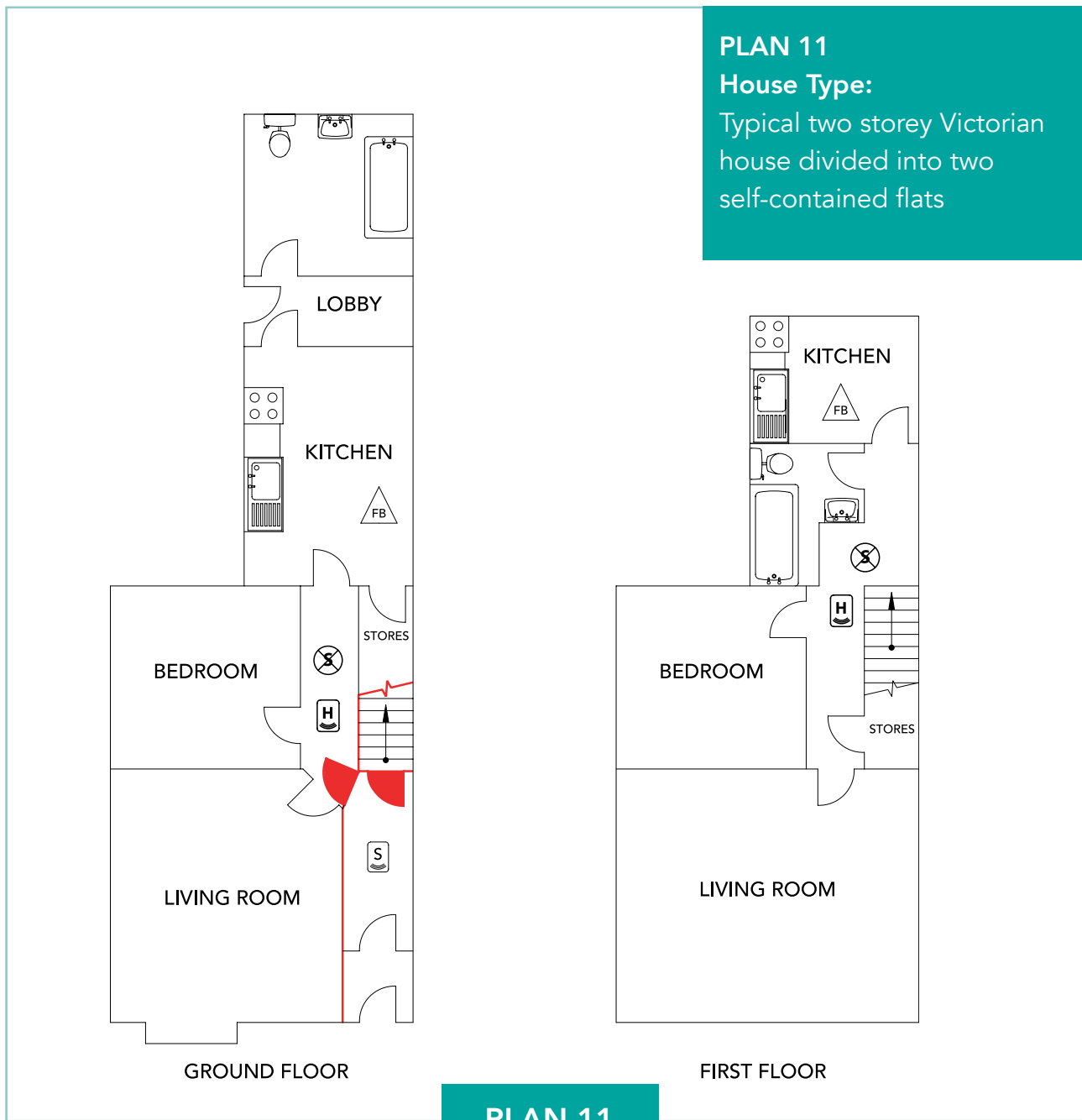

This scheme is designed in particular to ensure that persons living in the first floor flat are given early warning of any fire on the ground floor.

The communal entrance hall must be made a protected route and the underside of the stairs must have 30 minutes fire protection.



## Chapter 5: Typical layouts of buildings converted into flats

### PLAN 11

#### SCHEDULE TO PLAN No. 11: Typical two storey Victorian house divided into two self-contained flats

<b>Detection/Warning</b>	<p>A mixed fire detection and warning system conforming to current BS 5839, Part 6 (or equivalent) must be provided. This consists of a GRADE D system giving a LD2 level of coverage, which includes smoke detectors in the communal areas and a heat detector in the lobby / hall or room to each flat.</p> <p>The main system is supplemented by a GRADE D system giving a LD3 level of coverage consisting of one or more single point smoke detector positioned in the lobby / hall or room of each flat, but these are not interlinked between each unit of accommodation.</p> <p>There are two types of smoke detector, 'ionisation' and 'optical'. Optical detectors are better in most situations, because they are less likely to give false alarms. See Appendix 1 for further details.</p>
<b>Control Panel</b>	Not required
<b>Emergency Lighting</b>	<p>Subject to a fire risk assessment emergency lighting should not be necessary, provided that the escape route is not long or complex and there is effective artificial or borrowed lighting.</p> <p>Where emergency lighting is considered to be necessary, it should be provided in accordance with the current BS 5266 Part 1 (or equivalent) to cover the protected escape route.</p> <p>The location of light fittings is to be determined by the design / installing engineer. See Appendix 2 for further information.</p>
<b>Protected Route</b>	<p>The protected escape route consists of the ground floor communal entrance hall only. This allows residents from all parts of the building to reach the outside without passing through a higher fire risk area. The protected route must be kept clear of obstructions and combustible materials. The walls and ceilings of all parts of the protected route <b>MUST</b> be free of highly flammable materials i.e. polystyrene tiles or heavy flock wallpaper.</p> <p>Electric meters within the protected route must be housed within a fire-resisting cupboard. Where gas meters are contained within the protected route see Appendix 9.</p> <p>See Appendix 3 for further information regarding fire resisting construction of walls/partitions.</p>

## Chapter 5: Typical layouts of buildings converted into flats

### PLAN 11

<b>SCHEDULE TO PLAN No. 11: Typical two storey Victorian house divided into two self-contained flats</b>	
<b>Fire Doors</b>	A fire door (FD30S) must be installed in each doorway leading onto the protected escape route. See Appendix 6 on fire doors.
<b>Security of Doors</b>	<p>Locks on individual flat and final exit doors must be capable of being opened from the inside without the use of keys. In addition, to improve the overall security of the property and to comply with advice from the Association of British Insurers, it is recommended that BS8621 mortice locks fitted with thumb turns are used on the exit doors; this is a mortice lock (sometimes called a sashlock) which conforms to British Standard BS8621 fitted with a 6 pin cylinder thumb turn.</p> <p>The doors should also be solid and at least 44mm (1<sup>3</sup>/<sub>4</sub>" ) thick and certified to British Standard PAS 24-1 'Doors of Enhanced Security'. For more information about BS8621 mortice thumb turn locks and PAS 24-1 doors please refer to the relevant section in Appendix 7: Door security.</p>
<b>Fire Separation</b>	Floor/ ceiling construction including the under-stairs store and cellars must achieve 30 minutes fire resistance. See Appendix 8 on how to achieve this.
<b>Fire Blankets</b>	A fire blanket to BS 6575 (or equivalent) is to be provided in each kitchen. The blanket must be mounted on the wall 1.5m high adjacent to an exit door away from the cooking facility.
<b>Extinguishers</b>	For further guidance see page 11.
<b>Other recommendations</b>	<p>Polystyrene ceiling tiles <b>should not</b> be used within the premises.</p> <p>Heaters – portable heaters using gas cylinders or flammable liquids <b>should not</b> be used or stored in the premises.</p>

## Chapter 5: Typical layouts of buildings converted into flats

### PLAN 12

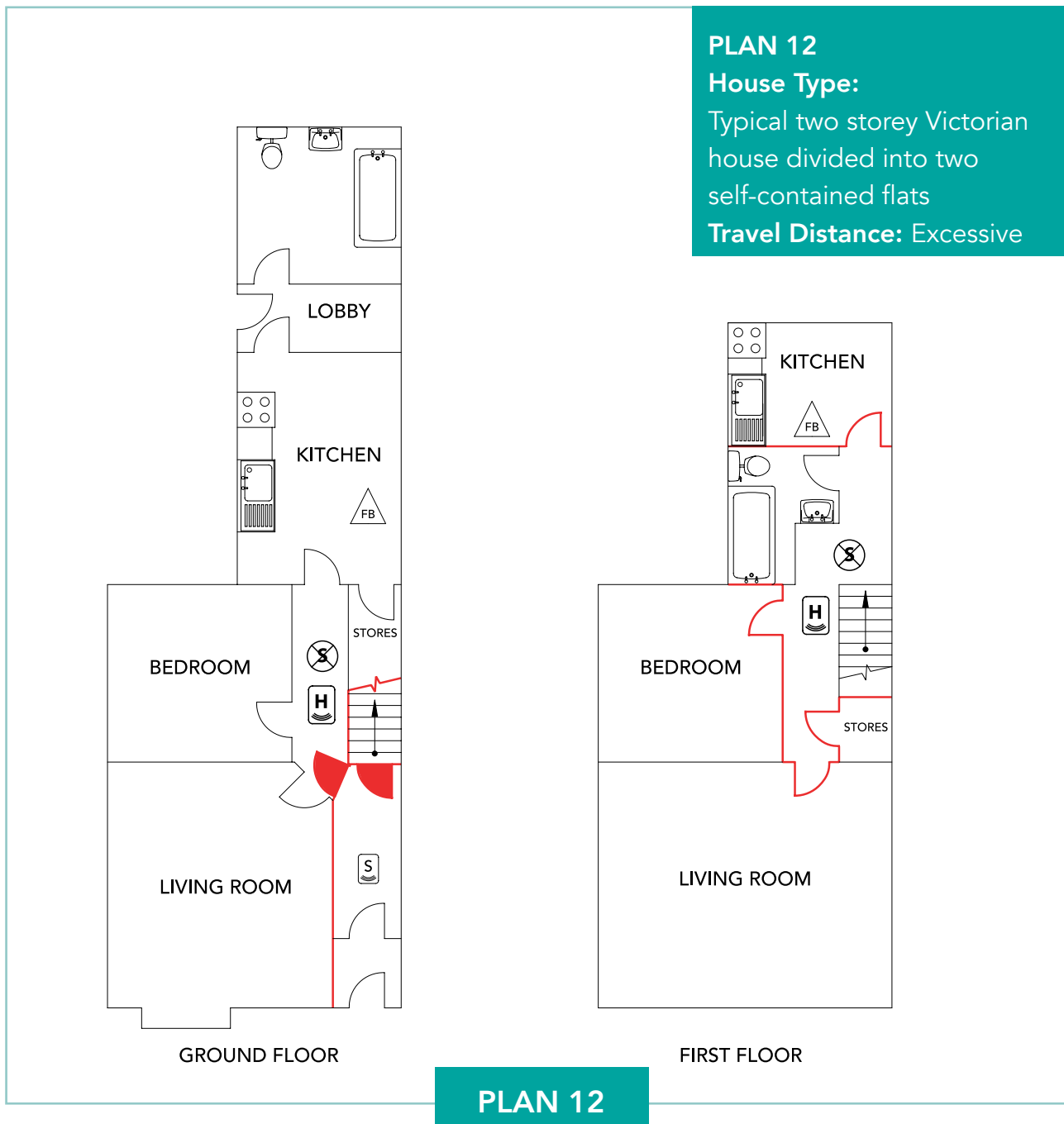

In large houses, the distance a person has to travel from the furthest point of any habitable room at first floor level to the nearest point of relative safety may be excessive (please refer to page 12 Travel Distances).

If this is the case then the first floor landing must be made into a protected route by fitting fire doors to all rooms leading on to the landing (excluding bathrooms and WCs containing no fire risk). These fire doors must be self closing but must not have cold smoke seals fitted. The protected route itself must not be excessive in length.

## Chapter 5: Typical layouts of buildings converted into flats

### PLAN 12

<b>SCHEDULE TO PLAN No. 12: Typical two storey Victorian house divided into two self-contained flats (Travel distance: excessive)</b>	
<b>Detection/Warning</b>	<p>A mixed fire detection and warning system conforming to current BS 5839, Part 6 (or equivalent) must be provided. This consists of a GRADE D system giving a LD2 level of coverage, which includes smoke detectors in the communal areas and a heat detector in the lobby / hall or room to each flat.</p> <p>The main system is supplemented by a GRADE D system giving a LD3 level of coverage consisting of one or more single point smoke detector positioned in the lobby / hall or room of each flat, but these are not interlinked between each unit of accommodation.</p> <p>There are two types of smoke detector, 'ionisation' and 'optical'. Optical detectors are better in most situations, because they are less likely to give false alarms. See Appendix 1 for further details.</p>
<b>Control Panel</b>	Not required
<b>Emergency Lighting</b>	<p>Subject to a fire risk assessment emergency lighting should not be necessary, provided that the escape route is not long or complex and there is effective artificial or borrowed lighting.</p> <p>Where emergency lighting is considered to be necessary, it should be provided in accordance with the current BS 5266 Part 1 (or equivalent) to cover the protected escape route.</p> <p>The location of light fittings is to be determined by the design / installing engineer. See Appendix 2 for further information.</p>
<b>Protected Route</b>	<p>The protected escape route consists of the first floor landing, the staircase and the ground floor communal entrance hall. This allows residents from all parts of the building to reach the outside without passing through a higher fire risk area.</p> <p>The protected route must be kept clear of obstructions and combustible materials. The walls and ceilings of all parts of the protected route MUST be free of highly flammable materials i.e. polystyrene tiles or heavy flock wallpaper.</p> <p>Subject to the findings of a fire risk assessment, electric meters within the protected route may need to be housed within a fire-resisting cupboard. Where gas meters are contained within the protected route see Appendix 9.</p>

## Chapter 5: Typical layouts of buildings converted into flats

### PLAN 12

<b>SCHEDULE TO PLAN No. 12: Typical two storey Victorian house divided into two self-contained flats (Travel distance: excessive)</b>	
<b>Protected Route</b> <i>(continued)</i>	See Appendix 3 for further information regarding fire resisting construction of walls/partitions.
<b>Fire Doors</b>	A fire door must be installed in each doorway leading onto the protected escape route except bathrooms / WCs containing no fire risk. See Appendix 6 on fire doors.
<b>Security of Doors</b>	<p>Locks on individual flat and final exit doors must be capable of being opened from the inside without the use of keys. In addition, to improve the overall security of the property and to comply with advice from the Association of British Insurers, it is recommended that BS8621 mortice locks fitted with thumb turns are used on these doors; this is a mortice lock (sometimes called a sashlock) which conforms to British Standard BS8621 fitted with a 6 pin cylinder thumb turn.</p> <p>The doors should also be solid and at least 44mm (1<sup>3</sup>/<sub>4</sub>"") thick and certified to British Standard PAS 24-1 'Doors of Enhanced Security'. For more information about BS8621 mortice thumb turn locks and PAS 24-1 doors please refer to the relevant section in Appendix 7: Door security.</p>
<b>Fire Separation</b>	Floor/ ceiling construction including the under-stairs store and cellars (if any) must achieve 30 minutes fire resistance. See Appendix 8 on how to achieve this.
<b>Fire Blankets</b>	A fire blanket to BS 6575 (or equivalent) is to be provided in each kitchen. The blanket must be mounted on the wall 1.5m high adjacent to an exit door away from the cooking facility.
<b>Extinguishers</b>	For further guidance see page 11.
<b>Other recommendations</b>	<p>Polystyrene ceiling tiles <b>should not</b> be used within the premises.</p> <p>Heaters – portable heaters using gas cylinders or flammable liquids <b>should not</b> be used or stored in the premises.</p>

Chapter 5: Typical layouts of buildings converted into flats

PLAN 13



The layout here is similar to the preferred means of escape option described for Plan 12. It is, however, an alternative to provide emergency escape windows from the habitable rooms at first floor level rather than making the landing a protected route by the fitting of fire doors.

## Chapter 5: Typical layouts of buildings converted into flats PLAN 13

### SCHEDULE TO PLAN No. 13: Typical two storey Victorian house divided into two self-contained flats (Travel distance: excessive) (Alternative scheme to Plan 12)

<b>Detection/Warning</b>	<p>A mixed fire detection and warning system conforming to current BS 5839, Part 6 (or equivalent) must be provided. This consists of a GRADE D system giving a LD2 level of coverage, which includes smoke detectors in the communal areas and a heat detector in the lobby / hall or room to each flat.</p> <p>The main system is supplemented by a GRADE D system giving a LD3 level of coverage consisting of one or more single point smoke detector positioned in the lobby / hall or room of each flat, but these are not interlinked between each unit of accommodation.</p> <p>There are two types of smoke detector, 'ionisation' and 'optical'. Optical detectors are better in most situations, because they are less likely to give false alarms. See Appendix 1 for further details.</p>
<b>Control Panel</b>	Not required
<b>Emergency Lighting</b>	<p>Subject to a fire risk assessment emergency lighting should not be necessary, provided that the escape route is not long or complex and there is effective artificial or borrowed lighting.</p> <p>Where emergency lighting is considered to be necessary, it should be provided in accordance with the current BS 5266 Part 1 (or equivalent) to cover the protected escape route.</p> <p>The location of light fittings is to be determined by the design / installing engineer. See Appendix 2 for further information.</p>
<b>Protected Route</b>	<p>The protected escape route consists of the ground floor communal entrance hall only. This allows residents from all parts of the building to reach the outside without passing through a higher fire risk area. The protected route must be kept clear of obstructions and combustible materials. The walls and ceilings of all parts of the protected route MUST be free of highly flammable materials i.e. polystyrene tiles or heavy flock wallpaper.</p> <p>In addition to the protected route, secondary means of escape arrangements should be made from the first floor via suitable escape window openings. See Appendices 4 and 5 referring to escape windows and window security respectively.</p>

## Chapter 5: Typical layouts of buildings converted into flats

### PLAN 13

#### SCHEDULE TO PLAN No. 13: Typical two storey Victorian house divided into two self-contained flats (Travel distance: excessive) (Alternative scheme to Plan 12)

<b>Protected Route</b> <i>(continued)</i>	<p>Subject to the findings of a fire risk assessment, electric meters within the protected route may need to be housed within a fire-resisting cupboard. Where gas meters are contained within the protected route see Appendix 9.</p> <p>See Appendix 3 for further information regarding fire-resisting construction of walls/partitions.</p>
<b>Fire Doors</b>	A fire door (FD30S) must be installed in each doorway leading onto the protected escape route. See Appendix 6 on fire doors.
<b>Security of Doors</b>	<p>Locks on individual flat and final exit doors must be capable of being opened from the inside without the use of keys. In addition, to improve the overall security of the property and to comply with advice from the Association of British Insurers, it is recommended that BS8621 mortice locks fitted with thumb turns are used on these doors; this is a mortice lock (sometimes called a sashlock) which conforms to British Standard BS8621 fitted with a 6 pin cylinder thumb turn.</p> <p>The doors should also be solid and at least 44mm (1<sup>3</sup>/<sub>4</sub>" ) thick and certified to British Standard PAS 24-1 'Doors of Enhanced Security'. For more information about BS8621 mortice thumb turn locks and PAS 24-1 doors please refer to the relevant section in Appendix 7: Door security.</p>
<b>Fire Separation</b>	Floor/ ceiling construction including the under-stairs store and cellars (if any) must achieve 30 minutes fire resistance. See Appendix 8 on how to achieve this.
<b>Fire Blankets</b>	A fire blanket to BS 6575 (or equivalent) is to be provided in each kitchen. The blanket must be mounted on the wall 1.5m high adjacent to an exit door away from the cooking facility.
<b>Extinguishers</b>	For further guidance see page 11.
<b>Other recommendations</b>	<p>Polystyrene ceiling tiles <b>should not</b> be used within the premises.</p> <p>Heaters – portable heaters using gas cylinders or flammable liquids <b>should not</b> be used or stored in the premises.</p>



## Chapter 5: Typical layouts of buildings converted into flats

### PLAN 14

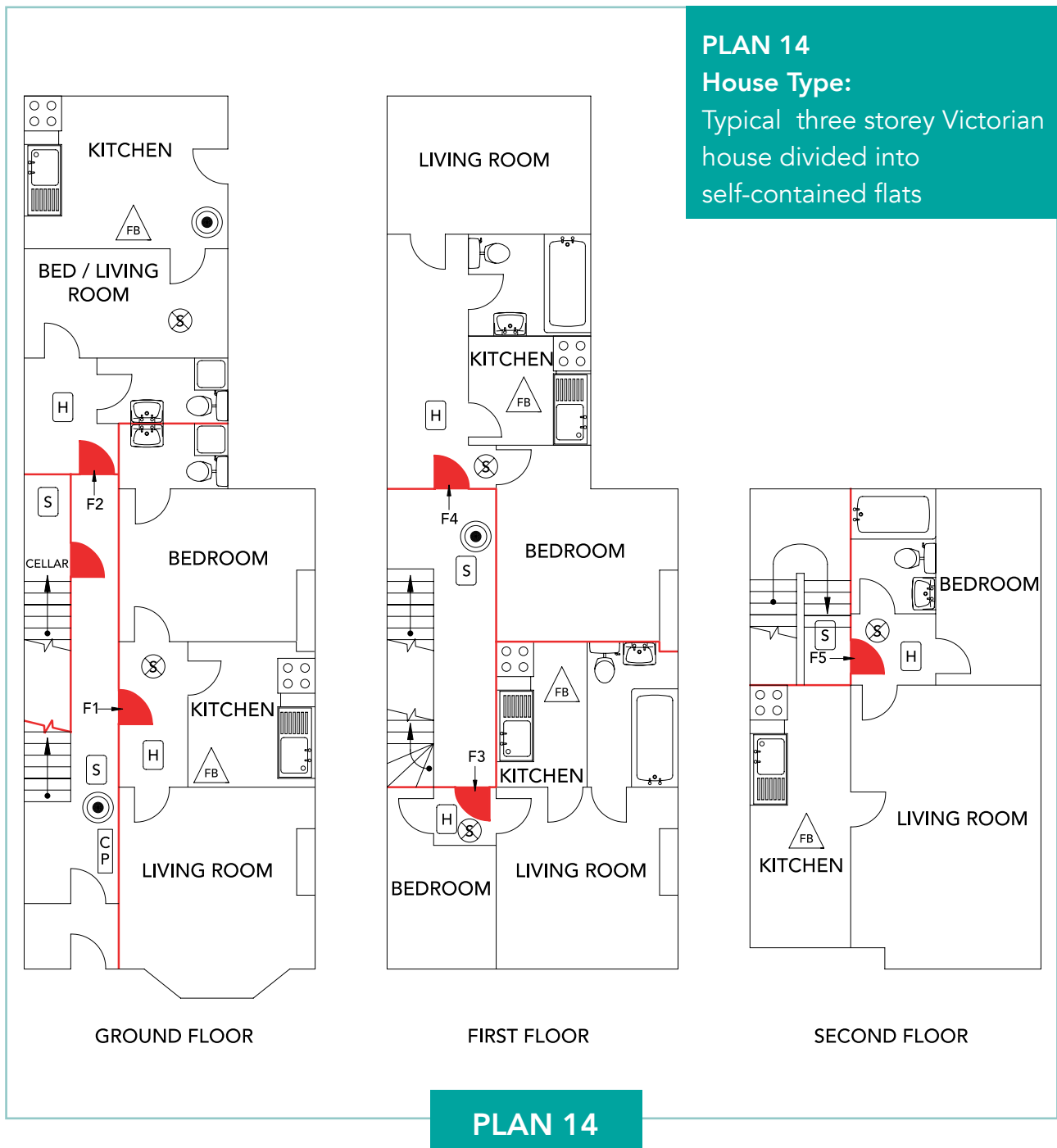

The communal escape route is given 30 minutes fire protection by fitting fire doors to the entrance of each flat (and to the cellar or any other identified fire risk rooms).

All occupiers are given early warning of a fire in any particular flat before it becomes serious enough to break out into the communal escape route.

The occupier(s) of any individual flat is given additional early warning of a fire in that flat by having a mains powered single point smoke alarm fitted which is not connected to the other flats in the house.

## Chapter 5: Typical layouts of buildings converted into flats

### PLAN 14

#### SCHEDULE TO PLAN No. 14: Typical three storey Victorian house divided into self-contained flats

<b>Detection/Warning</b>	<p>A mixed fire detection and warning system conforming to current BS 5839, part 6, (or equivalent) must be provided.</p> <p>This consists of a Grade A main system giving an LD2 level of coverage, which includes smoke detectors at each floor level in the communal areas and cellar head, and heat detectors in the adjoining lobby/hall or room to each flat. The main system is supplemented by one or more single point Grade D smoke alarms also in lobby/hall or room to each flat, but these are not interlinked between each unit of accommodation.</p> <p>There are two types of smoke detector, 'ionisation' and 'optical'. Optical detectors are better in most situations, because they are less likely to give false alarms. See Appendix 1 for further details.</p>
<b>Control Panel</b>	<p>To be sited close to the normal main entrance to the dwelling.</p>
<b>Emergency Lighting</b>	<p>Subject to a fire risk assessment emergency lighting should not be necessary, provided that the escape route is not long or complex and there is effective artificial or borrowed lighting.</p> <p>Where emergency lighting is considered to be necessary, it should be provided in accordance with the current BS 5266 Part 1 (or equivalent) to cover the protected escape route.</p> <p>The location of light fittings is to be determined by the design / installing engineer. See Appendix 2 for further information.</p>
<b>Protected Route</b>	<p>The protected escape route comprises the communal entrance hall, stairs and landings, and is designed to allow for residents from all parts of the building to reach the outside without passing through a higher fire risk area.</p> <p>Within each flat the residents must be able to reach the entrance door to the flat from the bedrooms without passing through another risk room.</p> <p>The protected route must be kept clear of obstruction and combustible materials. The walls and ceilings of all parts of the protected route MUST be free of highly flammable materials i.e. polystyrene tiles or heavy flock wallpaper.</p>

## Chapter 5: Typical layouts of buildings converted into flats

### PLAN 14

#### SCHEDULE TO PLAN No. 14: Typical three storey Victorian house divided into self-contained flats

<b>Protected Route</b> <i>(continued)</i>	<p>Subject to the findings of a fire risk assessment, electric meters within the protected route may need to be housed within a fire-resisting cupboard. Where gas meters are contained within the protected route see Appendix 9.</p> <p>See Appendix 3 for further information regarding fire-resisting construction of walls/partitions.</p>
<b>Fire Doors</b>	A fire door (FD30S) must be installed in each doorway leading onto the protected escape route. See Appendix 6 on fire doors.
<b>Security of Doors</b>	<p>Locks on individual flat and final exit doors must be capable of being opened from the inside without the use of keys. In addition, to improve the overall security of the property and to comply with advice from the Association of British Insurers, it is recommended that BS8621 mortice locks fitted with thumb turns are used on these doors; this is a mortice lock (sometimes called a sashlock) which conforms to British Standard BS8621 fitted with a 6 pin cylinder thumb turn.</p> <p>The doors should also be solid and at least 44mm (1<sup>3</sup>/<sub>4</sub>"") thick and certified to British Standard PAS 24-1 'Doors of Enhanced Security'. For more information about BS8621 mortice thumb turn locks and PAS 24-1 doors please refer to the relevant section in Appendix 7 Door Security.</p>
<b>Fire Separation</b>	Floor/ceiling construction including the under-stairs store and cellars (if any) must achieve 30 minutes fire resistance. See Appendix 8 on how to achieve this.
<b>Fire Blankets</b>	A fire blanket to BS 6575 (or equivalent) is to be provided in each kitchen. The blanket must be mounted on the wall 1.5m high adjacent to an exit door away from the cooking facility.
<b>Extinguishers</b>	For further guidance see page 11.
<b>Other recommendations</b>	<p>Polystyrene ceiling tiles <b>should not</b> be used within the premises.</p> <p>Heaters – portable heaters using gas cylinders or flammable liquids <b>should not</b> be used or stored in the premises.</p>

## Chapter 5: Typical layouts of buildings converted into flats

### PLAN 15

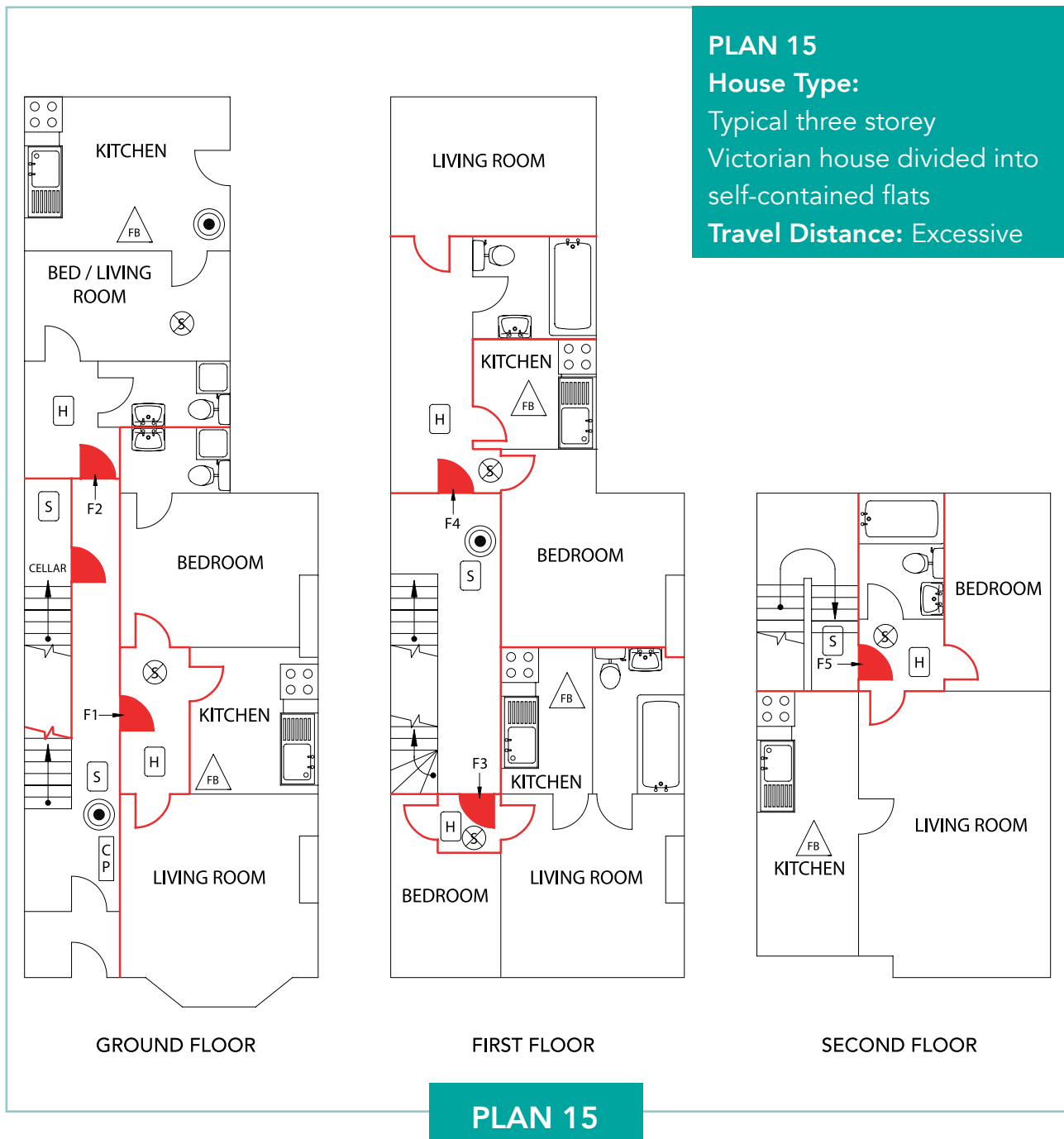

In larger houses, the travel distance from the furthest point of any habitable room within any particular flat to the entrance door of that flat may be excessive.

In such cases it is necessary, therefore, to give the occupier(s) of that flat additional time to get out before a fire occurs within the flat blocking their escape route.

This is achieved by creating a protected lobby or corridor (not to exceed 9 metres in length) within the flat by fitting fire doors to all doorways (excluding bathrooms and WCs containing no fire risk) leading onto the lobby or corridor. The fire doors within the flat need not be fitted with cold smoke seals but must incorporate intumescent strips. The fire alarm system would be unchanged from that shown for Plan 14.

## Chapter 5: Typical layouts of buildings converted into flats

### PLAN 15

<b>SCHEDULE TO PLAN No. 15: Typical three storey Victorian house divided into self-contained flats (travel distance: excessive)</b>	
<b>Detection/Warning</b>	<p>A mixed fire detection and warning system conforming to current BS 5839, part 6; (or equivalent) must be provided.</p> <p>This consists of a Grade A main system giving an LD2 level of coverage, which includes smoke detectors at each floor level in the communal areas and cellar head, and heat detectors in the adjoining lobby/hall or room to each flat. The main system is supplemented by one or more single point Grade D smoke alarms also in lobby/hall or room to each flat, but these are not interlinked between each unit of accommodation.</p> <p>There are two types of smoke detector, 'ionisation' and 'optical'. Optical detectors are better in most situations, because they are less likely to give false alarms. See Appendix 1 for further details.</p>
<b>Control Panel</b>	To be sited close to the normal main entrance to the dwelling.
<b>Emergency Lighting</b>	<p>Subject to a fire risk assessment emergency lighting should not be necessary, provided that the escape route is not long or complex and there is effective artificial or borrowed lighting.</p> <p>Where emergency lighting is considered to be necessary, it should be provided in accordance with the current BS 5266 Part 1 (or equivalent) to cover the protected escape route.</p> <p>The location of light fittings is to be determined by the design / installing engineer. See Appendix 2 for further information.</p>
<b>Protected Route</b>	<p>The protected escape route comprises the communal entrance hall, stairs, landings and also a protected lobby/corridor within the flats. It is designed to allow residents from all parts of the building to reach the outside without passing through a higher fire risk area. Within each flat the residents must be able to reach the entrance door to the flat from the bedrooms without passing through another risk room.</p> <p>The protected route must be kept clear of obstruction and combustible materials. The walls and ceilings of all parts of the protected route MUST be free of highly flammable materials i.e. polystyrene tiles or heavy flock wallpaper.</p>

## Chapter 5: Typical layouts of buildings converted into flats

### PLAN 15

#### SCHEDULE TO PLAN No. 15: Typical three storey Victorian house divided into self-contained flats (travel distance: excessive)

<b>Protected Route</b> <i>(continued)</i>	<p>Subject to the findings of a fire risk assessment, electric meters within the protected route may need to be housed within a fire-resisting cupboard. Where gas meters are contained within the protected route see Appendix 9.</p> <p>See Appendix 3 for further information regarding fire-resisting construction of walls/partitions.</p>
<b>Fire Doors</b>	A fire door must be installed in each doorway leading onto the protected escape route. See Appendix 6 on fire doors.
<b>Security of Doors</b>	<p>Locks on individual flat and final exit doors must be capable of being opened from the inside without the use of keys. In addition, to improve the overall security of the property and to comply with advice from the Association of British Insurers, it is recommended that BS8621 mortice locks fitted with thumb turns are used on these doors; this is a mortice lock (sometimes called a sashlock) which conforms to British Standard BS8621 fitted with a 6 pin cylinder thumb turn.</p> <p>The doors should also be solid and at least 44mm (1<sup>3</sup>/<sub>4</sub>" ) thick and certified to British Standard PAS 24-1 'Doors of Enhanced Security'. For more information about BS8621 mortice thumb turn locks and PAS 24-1 doors please refer to the relevant section in Appendix 7: Door Security.</p>
<b>Fire Separation</b>	Floor/ceiling construction including the under-stairs store and cellars (if any) must achieve 30 minutes fire resistance. See Appendix 8 on how to achieve this.
<b>Fire Blankets</b>	A fire blanket to BS 6575 (or equivalent) is to be provided in each kitchen. The blanket must be mounted on the wall 1.5m high adjacent to an exit door away from the cooking facility.
<b>Extinguishers</b>	For further guidance see page 11.
<b>Other recommendations</b>	<p>Polystyrene ceiling tiles <b>should not</b> be used within the premises.</p> <p>Heaters – portable heaters using gas cylinders or flammable liquids <b>should not</b> be used or stored in the premises.</p>

## Chapter 5: Typical layouts of buildings converted into flats

### PLAN 16

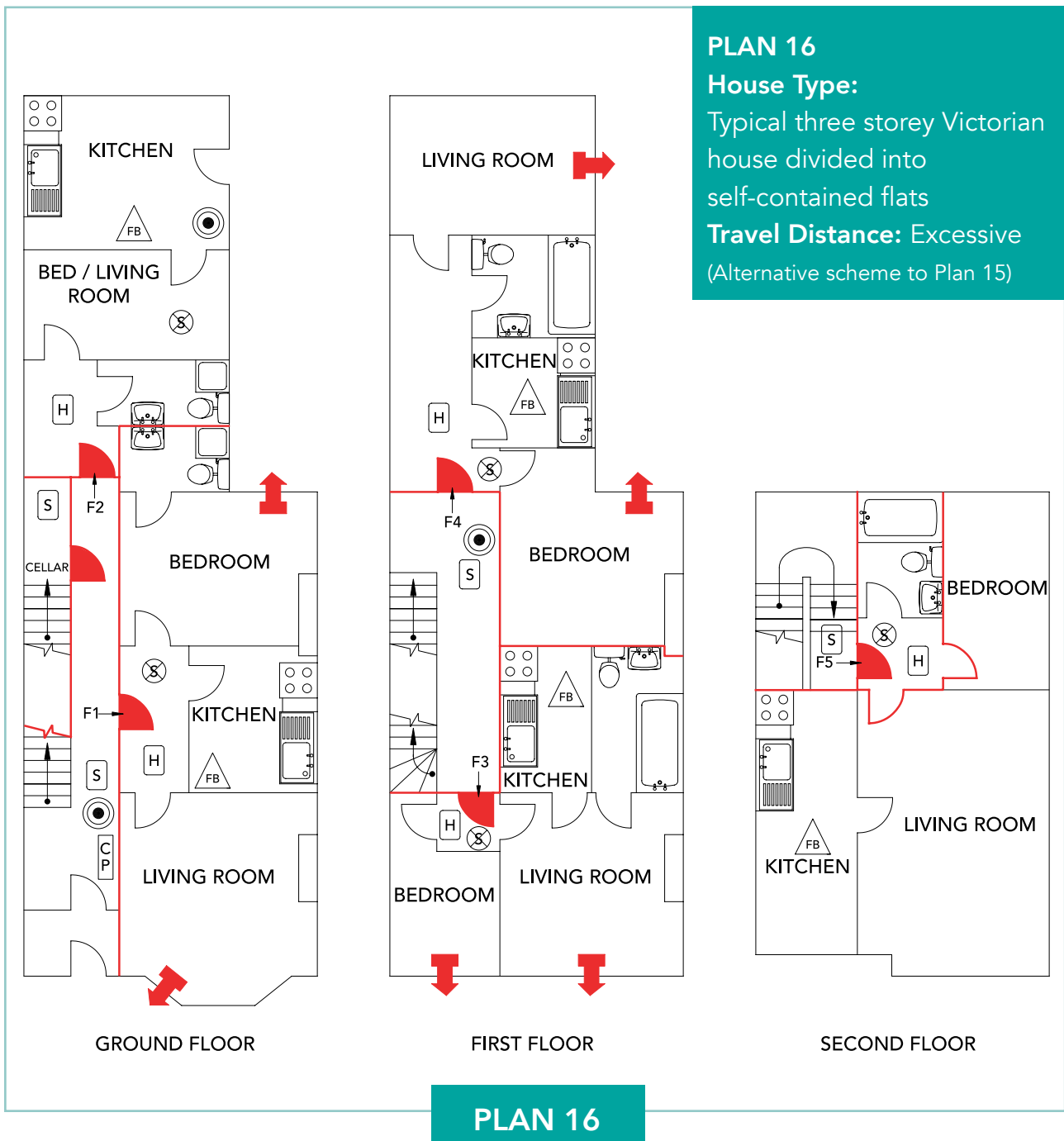

Where travel distances are excessive within the flat as described in relation to the preferred means of escape option shown in Plan 15, it is an alternative to provide emergency escape windows from habitable rooms at ground and first floor levels only, rather than fitting fire doors to create protected lobbies or corridors.

A protected lobby would still, however, need to be provided to the second floor flat if travel distances within that flat were excessive. The fire alarm system would again be unchanged from that shown for Plan 14.

## Chapter 5: Typical layouts of buildings converted into flats PLAN 16

### SCHEDULE TO PLAN No. 16: Typical three storey Victorian house divided into self-contained flats (Travel distance: excessive) (Alternative scheme to Plan 15)

<b>Detection/Warning</b>	<p>A mixed fire detection and warning system conforming to current BS 5839, part 6; (or equivalent) must be provided.</p> <p>This consists of a Grade A main system giving an LD2 level of coverage, which includes smoke detectors at each floor level in the communal areas and cellar head, and heat detectors in the adjoining lobby/hall or room to each flat. The main system is supplemented by one or more single point Grade D smoke alarms also in lobby or hall to each flat, but these are not interlinked between each unit of accommodation.</p> <p>There are two types of smoke detector, 'ionisation' and 'optical'. Optical detectors are better in most situations, because they are less likely to give false alarms. See Appendix 1 for further details.</p>
<b>Control Panel</b>	To be sited close to the normal main entrance to the dwelling.
<b>Emergency Lighting</b>	<p>Subject to a fire risk assessment emergency lighting should not be necessary, provided that the escape route is not long or complex and there is effective artificial or borrowed lighting.</p> <p>Where emergency lighting is considered to be necessary, it should be provided in accordance with the current BS 5266 Part 1 (or equivalent) to cover the protected escape route.</p> <p>The location of light fittings is to be determined by the design / installing engineer. See Appendix 2 for further information.</p>
<b>Protected Route</b>	<p>The protected escape route comprises the communal entrance hall, stairs and landings, and is designed to allow for residents from all parts of the building to reach the outside without passing through a higher fire risk area. Within each flat the residents must be able to reach the entrance door to the flat from the bedrooms without passing through another risk room.</p> <p>The protected route must be kept clear of obstruction and combustible materials. The walls and ceilings of all parts of the protected route MUST be free of highly flammable materials i.e. polystyrene tiles or heavy flock wallpaper.</p>



## Chapter 5: Typical layouts of buildings converted into flats PLAN 16

### SCHEDULE TO PLAN No. 16: Typical three storey Victorian house divided into self-contained flats (Travel distance: excessive) (Alternative scheme to Plan 15)

<b>Protected Route</b> <i>(continued)</i>	<p>In addition to the protected route, secondary means of escape arrangements should be made from the ground and first floor via suitable escape window openings. See Appendices 4 and 5 referring to escape windows and window security respectively.</p> <p>Subject to the findings of a fire risk assessment, electric meters within the protected route may need to be housed within a fire-resisting cupboard. Where gas meters are contained within the protected route see Appendix 9.</p>
<b>Fire Doors</b>	<p>Fire doors must be installed in each doorway leading onto the protected escape route and all risk area rooms to the second floor. See Appendix 6 on fire doors.</p>
<b>Security of Doors</b>	<p>Locks on individual flat and final exit doors must be capable of being opened from the inside without the use of keys.</p> <p>In addition, to improve the overall security of the property and to comply with advice from the Association of British Insurers, it is recommended that BS8621 mortice locks fitted with thumb turns are used on these doors; this is a mortice lock (sometimes called a sashlock) which conforms to British Standard BS8621 fitted with a 6 pin cylinder thumb turn.</p> <p>The doors should also be solid and at least 44mm (1<sup>3</sup>/<sub>4</sub>" thick and certified to British Standard PAS 24-1 'Doors of Enhanced Security'. For more information about BS8621 mortice thumb turn locks and PAS 24-1 doors please refer to the relevant section in Appendix 7: Door security.</p>
<b>Fire Separation</b>	<p>Floor/ceiling construction including the under-stairs store and cellars (if any) must achieve 30 minutes fire resistance. See Appendix 8 on how to achieve this.</p>
<b>Fire Blankets</b>	<p>A fire blanket to BS 6575 (or equivalent) is to be provided in each kitchen. The blanket must be mounted on the wall 1.5m high adjacent to an exit door away from the cooking facility.</p>
<b>Extinguishers</b>	<p>For further guidance see page 11.</p>
<b>Other recommendations</b>	<p>Polystyrene ceiling tiles <b>should not</b> be used within the premises.</p> <p>Heaters – portable heaters using gas cylinders or flammable liquids <b>should not</b> be used or stored in the premises.</p>

# Chapter 6: Maintenance of fire protection

Once the fire precautions have been installed, the owner and the residents both have responsibility for their maintenance.

## Owner's Responsibility

The owner must make sure the structural fire precautions, the fire alarm system and other equipment are maintained in good condition and proper working order.

## The Fire Alarm System

As an owner or manager you must be familiar with how the fire alarm system operates and know how to recognise faults and get them put right. Your alarm installer will have left you with an operator's manual and a contact telephone number. It is very important to report faults as soon as you are aware of them.

A BS 5839 Part 6 Grade A (or equivalent) system with a control panel must be checked and serviced regularly by a qualified electrician or alarm engineer. This British Standard also calls for weekly and quarterly tests of different call points. Keep a record of the checks carried out for future reference, in the book provided by the installer.

As the owner or manager, you can check a BS 5839 Part 6 Grade D (or equivalent) system without a control panel by carrying out the following actions:-

- the alarm system should be tested, by checking that all alarms activate simultaneously and air intake grills should be cleared of dust, insects and cobwebs

- back-up batteries should be replaced when necessary, in line with the manufacturer's recommendations.

Do this monthly and keep a written record. The detector should be replaced after ten years.

## Emergency Lighting

You should test this monthly and keep records of the checks. Some systems need the electrical supply to be switched off for three hours, so that the internal batteries can be completely discharged (this helps to prolong the life of the batteries).

## Fire Doors

These should be checked regularly to ensure that the doors and frames are undamaged and that self-closing devices work properly. The smoke seals to the doors must be undamaged and form a good seal between the door and frame.

## Fire Blankets and Extinguishers

If provided, these should be checked to make sure they are in place and available for use. Extinguishers must be tested on an annual basis, and in accordance with the manufacturer's instructions.

## Escape Routes

Check routes regularly to make sure they are clear from obstruction and free from combustible materials.

## Informing Residents about Fire Protection

You should tell existing residents about the fire protection system as soon as it is installed, and remember to tell new

residents as soon as they move in. You should make sure that all residents know:

- what the fire alarm is for and how to recognise the sound
- what the escape route is (a practice fire drill is a good idea for all new residents)
- the importance of not propping open fire doors or interfering with the alarm system.

### **Residents' Responsibility**

Residents must allow the owner reasonable access to the accommodation to carry out checks on fire precautions. Residents must not interfere with the fire protection system and equipment, for example, by:

- removing safety equipment
- propping fire doors open
- covering or removing smoke detectors
- blocking escape routes with furniture, bicycles or rubbish etc.

## Chapter 7: Fire prevention

The advice given in this booklet has mainly been concerned with methods of giving residents enough warning once a fire has started, and with precautions to control the spread of fire and smoke.

However, even the most thorough fire protection measures can never guarantee absolute safety for residents, or prevent extensive property damage. It is more important to look at ways of preventing a fire from starting.

The most important steps that you, as an owner or manager, can take to minimise the risk of a fire are:

1. Make sure that the electrical circuits, fittings and equipment throughout the house are in good condition. Have the electrical installation checked regularly by a competent electrician (NICEIC or ECA approved) and act quickly on any recommendations that are made.

The electrician's report will tell you the date on which the installation should be checked again.

Modern electrical wiring has circuit breakers rather than rewirable fuses.

These respond much more quickly to a short circuit or overload and will shut off the electricity supply before a fire has a chance to develop.

Ensure that there are enough electrical sockets for the appliances your residents are likely to use.

If you buy new electrical equipment, make sure that it bears the CE mark, either on the equipment itself, or on the box, to show that it complies with legal standards. The purchase of second hand electrical goods is not recommended.

2. Have the gas installation (i.e. the gas pipework, meters, gas fires, cookers, boilers, water heaters and flues) checked and serviced at least once a year by a registered gas fitter. This is a legal requirement under the Gas Safety (Installation and Use) Regulations.

You must give a copy of the safety certificate to each resident within 28 days, and give a copy to new residents before they move in.

3. Make sure that heaters are fixed in a position where they will not set fire to curtains, bedding or furnishings.
4. Make sure that all upholstered furniture that you, as the landlord, provide (such as settees, armchairs, bed bases and mattresses) has sewn-in labels showing that it has fire-resistant filling and covers.

This is a legal requirement under the Furniture and Furnishings (Fire) (Safety) Regulations 1988 and the Furniture and Furnishings (Fire) (Safety) (Amendment) Regulations 1993.

5. Prohibiting the use of portable gas or paraffin heaters in the house.

6. Do not store highly flammable materials in the house (such as paint, thinners, LPG cylinders, paraffin or petrol).
7. Do not store large quantities of combustible materials such as cardboard boxes or newspapers, in understairs cupboards, cellars, or in the loft.
8. Make sure that your residents understand the dangers of:
  - smoking in bed or when drowsy
  - careless use of candles or joss sticks
  - overloading electrical sockets
  - having trailing cables
  - leaving a chip pan or frying pan unattended, or over-full of oil or fat
  - placing clothes to dry over or near heaters;

and the importance of a bedtime fire safety routine:

- turning off the cooker
- unplugging electrical appliances (except those designed to stay on all the time)
- making sure that no cigarettes or candles are left burning
- closing all doors.

You should advise residents that in the event of a fire:-

- **Do not** attempt to fight fires that have already taken hold: evacuate yourself and your family from the house. If you share the house with other people sound the alarm as you make your escape
- **Do not** try to rescue belongings or pets. Your life and the lives of your family are too precious to risk
- **Telephone the Fire Service on 999 immediately from a place of safety.** Speak slowly and try to be calm answering the questions you are asked. If you think there may be someone left in the building inform the 999 operator.

**If in doubt: get out!**

# Appendices

## Appendix 1: Automatic fire detection and alarm systems

### 1. Fire Alarm System to comply with Current British Standard 5839 Part 6: Grade A (or equivalent)

This comprises a system of electrically operated smoke and/or heat detectors, which are linked to a control panel to give information on the location of the fire or any fault, which may develop.

The control panel must conform to current British Standard 5839 Part 4 (or equivalent).

In general the system must incorporate manual call points, which should be located on each floor level and at final points of exit.

The alarm signal must achieve sound levels of:-

- Not less than 65dB (A) in all accessible parts of the building
- Not less than 75dB (A) at all bed heads, to rouse sleeping persons when all doors are shut.

It is up to the installation contractor to specify the appropriate number and location of alarm sounders to achieve these sound levels.

### 2. Fire Alarm System to comply with Current British Standard 5839 Part 6: Grade D (or equivalent)

This comprises a system of one or more interlinked mains powered smoke and/or heat detectors each with an integral stand by battery and built in alarm.

A control panel is not required with this system, nor is the provision of manual call points.

### 3. Mixed grade systems

Installations where more than one alarm system is installed to serve the whole building are termed 'mixed systems.' These systems are installed to meet differing life safety objectives and may be two differing grades, having regard for the need to avoid false alarms from one dwelling unit affecting all occupiers.

Table 1 of BS 5839 Part 6 recommends a mixed system for HMOs of three storeys and above (grade A for communal areas and grade D within individual dwelling units). However, for shared house HMOs of normal risk on the basis of risk assessment, this guidance does not recommend a mixed system, as detection is not normally recommended within bedrooms in this type of accommodation.

### 4. Levels of coverage of automatic fire detection and warning systems as specified in BS 5839 Part 6 (2004)

- **LD1 coverage:** a system installed throughout the dwelling incorporating detectors in all circulation spaces that form part of the escape routes from the dwelling, and in all rooms and areas in which fire might start i.e. risk rooms
- **LD2 coverage:** a system incorporating detectors in all circulation spaces that form

## Appendix 1: Automatic fire detection and alarm systems

part of the escape routes from the dwelling and in all rooms or areas that present a high risk of fire to occupants i.e. risk rooms

- **LD3 coverage:** a system incorporating detectors in circulation spaces that form part of the escape routes from the dwelling only.

### General requirements common to all systems

#### (i) Mounting position

Smoke/heat detectors should preferably be mounted on ceilings and should be located at least 300mm horizontally from any wall/beam or light fitting.

#### (ii) Obstructions

If the passage of smoke or hot gases to a detector is likely to be disturbed by a ceiling obstruction (such as a beam) having a depth greater than 150mm, then detectors should be provided on each side of the obstruction.

#### (iii) Power supply

The power supply to the fire detection system must be taken from the landlord's supply.

#### (iv) Mixed use buildings

Where there is a mixture of residential and commercial use within the same building, the fire alarm system may be required to be installed in accordance with the current British Standard 5839 Part 1 (or equivalent). Contact the Local Authority for further advice in these circumstances.

#### (v) Certification

Fire alarm systems must be installed by a suitably qualified electrical contractor.

Upon completion, the contractor must provide an installation, commissioning and test certificate (see model certificate Appendix 1A).

**Certificate of installation and commissioning  
of the fire detection and alarm system  
at:**

Address \_\_\_\_\_  
\_\_\_\_\_  
\_\_\_\_\_

Postcode \_\_\_\_\_

It is certified that the fire detection and alarm system at the above address conforms to the recommendations of BS 5839: Part 6 for a type \_\_\_\_\_ grade \_\_\_\_\_ system, other than in respect of the following deviations.

The entire system has been tested for satisfactory operation.

Instructions in accordance with the recommendations of clause 22 of BS 5839: Part 6 have been supplied to:

\_\_\_\_\_  
\_\_\_\_\_

Signed \_\_\_\_\_ Dated \_\_\_\_\_

For and on behalf of  
\_\_\_\_\_  
\_\_\_\_\_  
\_\_\_\_\_



### **Provision of an Emergency Lighting System to comply with Current British Standard 5266 Part 1 (or equivalent).**

This is a system of battery-powered lights, where the battery is continuously trickle charged from the mains supply.

The lights are to be located on the fire escape route and are designed to operate if the local primary lighting sub-circuit fails, via a relay switch.

The wiring should be carried out in twin and earth cable and power must be taken directly from the landlord's supply.

The installation must be carried out by a qualified electrical contractor.

Upon completion, the contractor must provide an appropriate certificate (see model certificate Appendix 2A).

**Emergency Lighting  
Completion Certificate for New Installation or Alterations**

Occupier/Owner \_\_\_\_\_

Address of premises \_\_\_\_\_

\_\_\_\_\_

\_\_\_\_\_

Postcode \_\_\_\_\_ Telephone No \_\_\_\_\_

I/We hereby certify that the emergency lighting, or part thereof, at the above premises has been installed and designed by me/us, and to the best of my/our knowledge and belief, the system complies with the appropriate recommendations given in BS EN 1838 and BS 5266 'Emergency Lighting' Part 1: 2005.

Code of Practice for the emergency lighting of premises other than cinemas and certain other specified premises used for entertainment published by BSI for a category NM/1 minimum installation, except as stated below.

\_\_\_\_\_

\_\_\_\_\_

\_\_\_\_\_

\_\_\_\_\_

Installer's Name \_\_\_\_\_

Installer's Address \_\_\_\_\_

\_\_\_\_\_

Postcode \_\_\_\_\_ Telephone No: \_\_\_\_\_

Signature of person responsible for design and installation of the system:

\_\_\_\_\_ Date \_\_\_\_\_

## Appendix 3: Fire resistance of walls and partitions

### A. New walls and partitions

Half hour fire resistance can be achieved by any of the following methods of construction:

- **Solid walls**

- (i) Masonry blockwork/brickwork  
100mm thick (load bearing)
- (ii) Masonry blockwork/brickwork  
75mm thick (non-load bearing)

- **Stud partitions**

The constructions given below apply to both faces of the wall or partitioning. They are also suitable for infilling spandrels to staircases providing adequate studding has been incorporated into the wall.

Partition walls to consist of a timber frame 75mm x 50mm minimum (non-load bearing) with head and sole plates, studs at 600mm centres and facing each side of:-

- (i) 12.5mm plasterboard finished with plaster skim
- (ii) 12.5mm fire rated plasterboard, unplastered
- (iii) Proprietary fire resisting insulation board installed in accordance with manufacturers specifications (see Diagram 1)

- **Manufactured partitions**

Proprietary cellular core partition e.g. paramount board or equivalent installed in accordance with manufacturer's specifications.

### Note:

In all cases, where partition walls are to be left unplastered, the joints must be taped and filled using joint compound as recommended by the board manufacturer.

Any gaps between the wall and surrounding structure should be filled flush using suitable fire-resisting jointing compound.

### Diagram 1: Example of fire resisting partitions (half hour fire resistance)

*The studding framework should be 75mm x 50mm and should be securely fixed where it joins floor, adjacent walls and true ceilings.*

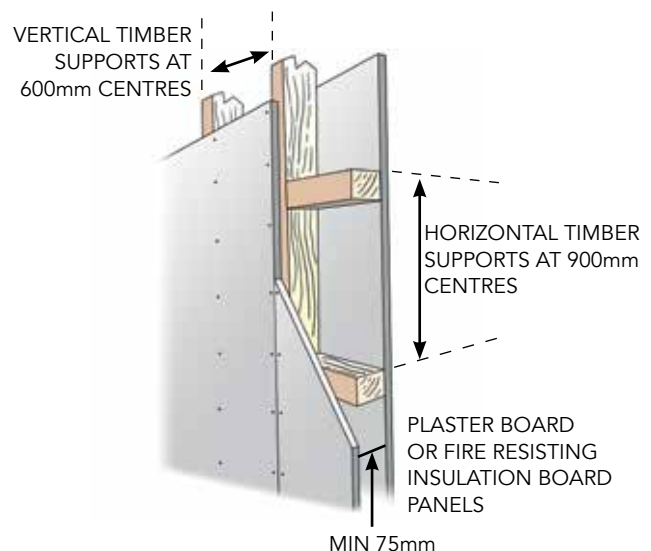
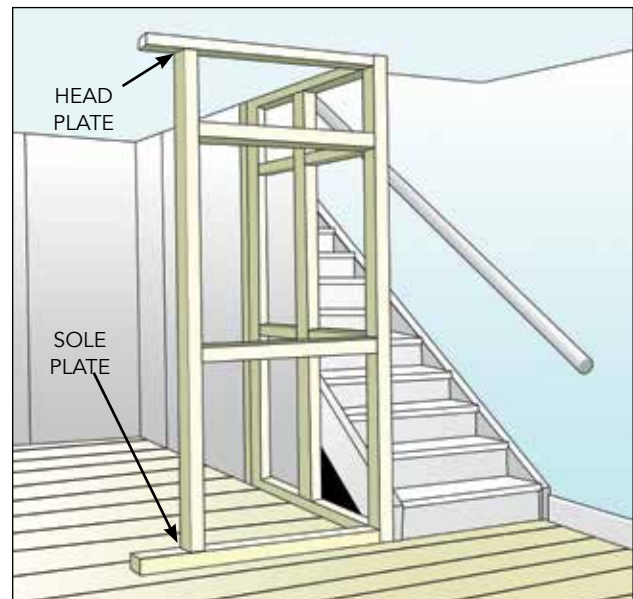

## Appendix 3: Fire resistance of walls and partitions

### **B. Upgrading existing lath and plaster partitions to achieve half hour fire resistance**

The condition of the lath and plaster partition must be examined in detail. Retention of the partition surfaces must only be considered if in good condition and there is no loose or failing plaster.

In the event of minor damage or inconclusive investigation of the partition construction, the partition must be upgraded on the risk side (room side) by replacing the lath and plaster or by overboarding it with 12.5mm gypsum wallboard or fireline board fixed with galvanised clout/plasterboard nails. These should have sufficient length to penetrate the lath and plaster and provide a firm fixing in the timber framework. The partition should be finished by scrimming and skimming with plaster.

### **C. Fire resisting glazing in walls and partitions**

For the purpose of this document glazing can be used to give periods of fire resistance of up to one hour, the actual fire resistance is determined by the nature and dimensions of the glass, the type of frame and method of securing the glass.

The limitations on the use of uninsulated fire resisting glazing for Building Regulation purposes are described below and it should be noted in this case that uninsulated fire resisting glazing is not permitted between

residential/sleeping accommodation and a protected corridor or lobby.

Wired glass should not be used in panes exceeding 1.2msq in area and should be 6mm thick for half hour fire resistance.

The design data for wired glazing in different frames is set out below and is applicable to glazed areas in walls and partitions.

The timber frame members and dividing bars should not be less than 56 mm deep and 44 mm wide with the rebate worked from the solid material. For the protection of timber beading intumescent paints have proved satisfactory.

See diagram 2 for methods of fixing.

## Appendix 3: Fire resistance of walls and partitions

**Diagram 2: Method of fixing for glazing in walls and partitions**

(i) Three dimensional view of glazed panel/window

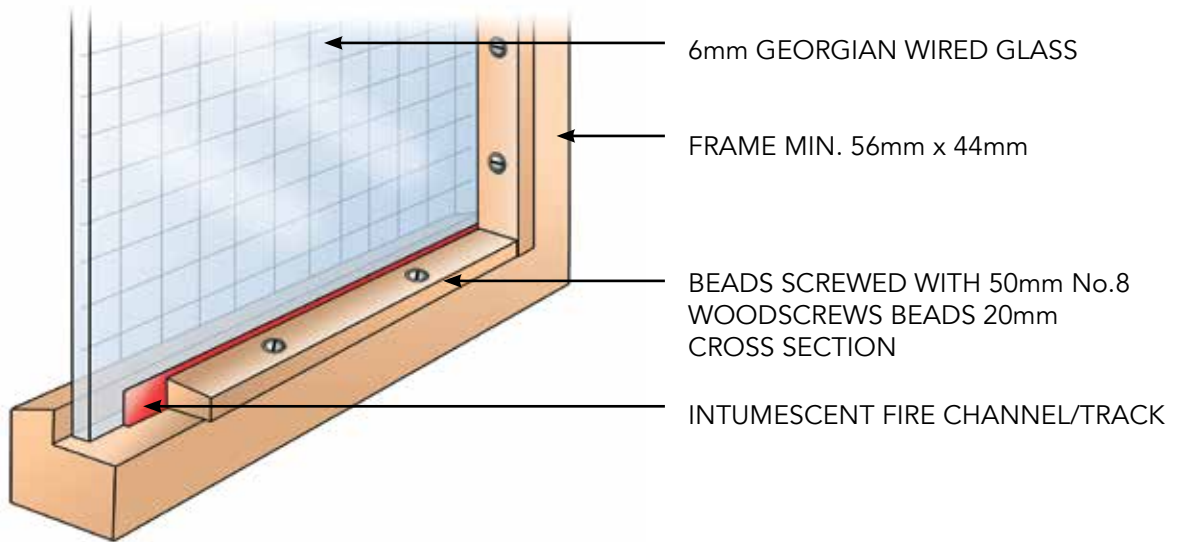

(ii) Cross section of glazed panel with glazing positioned centrally

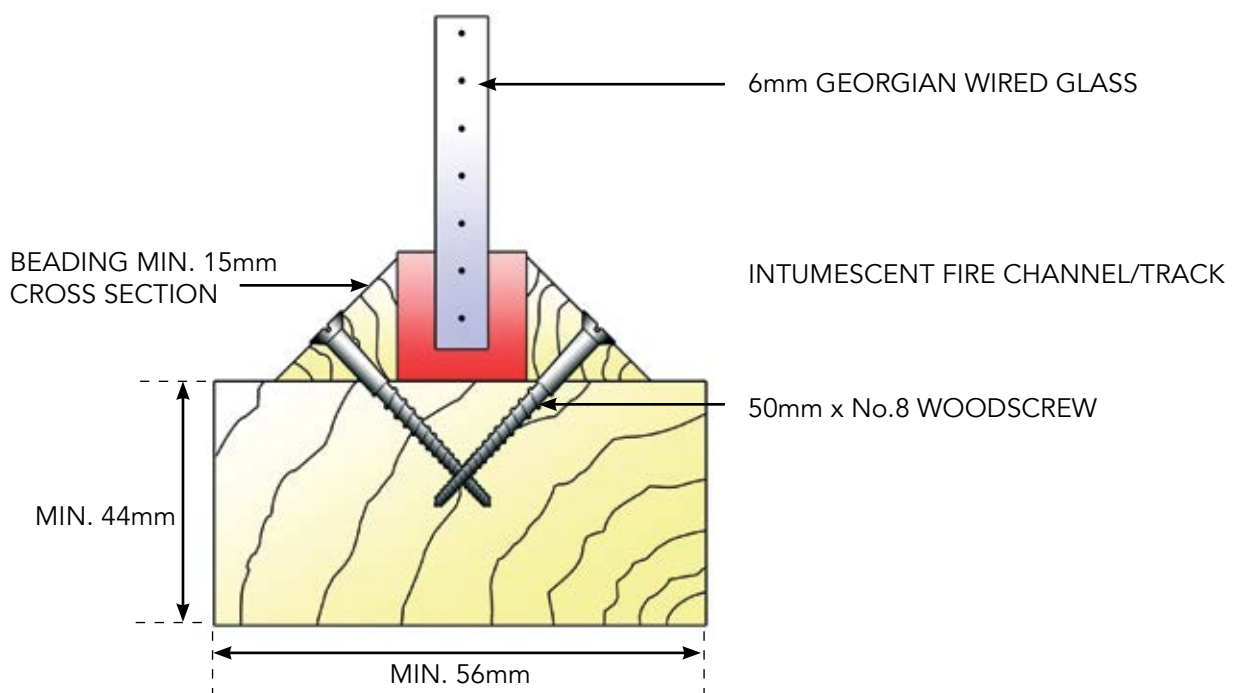

## Appendix 3: Fire resistance of walls and partitions

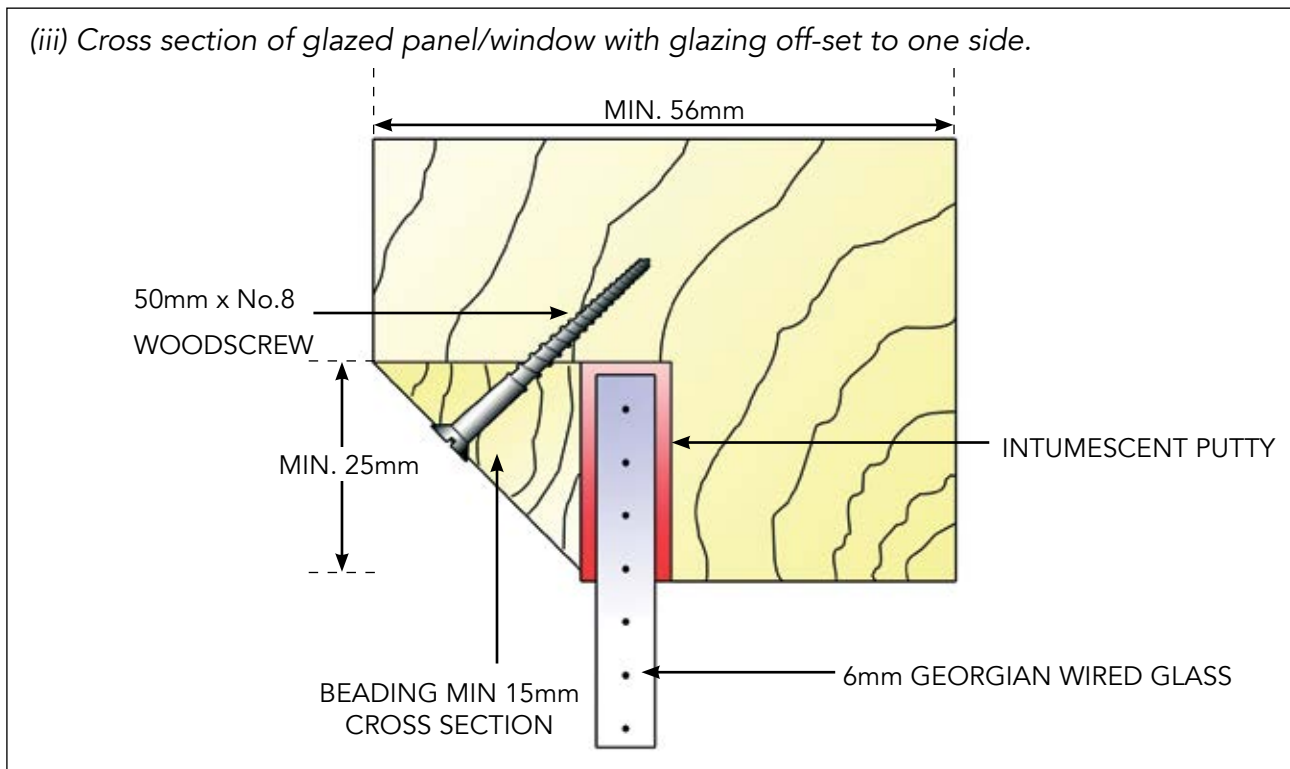

### Note:

This guidance is for providing fire resisting glazing in partitions only. It does not relate to glazing in fire doors. A fire door has to be designed specifically to accommodate glazing.

If glazing is required in a fire door then purpose made doors should be obtained.

### Safety Glazing

Glazing in critical locations (i.e. where there is a danger of falling through or of lacerations) may need to meet both fire resistance and safety standards i.e the use of fire resisting safety glazing complying with current British Standard 6206: 1981 (or equivalent).

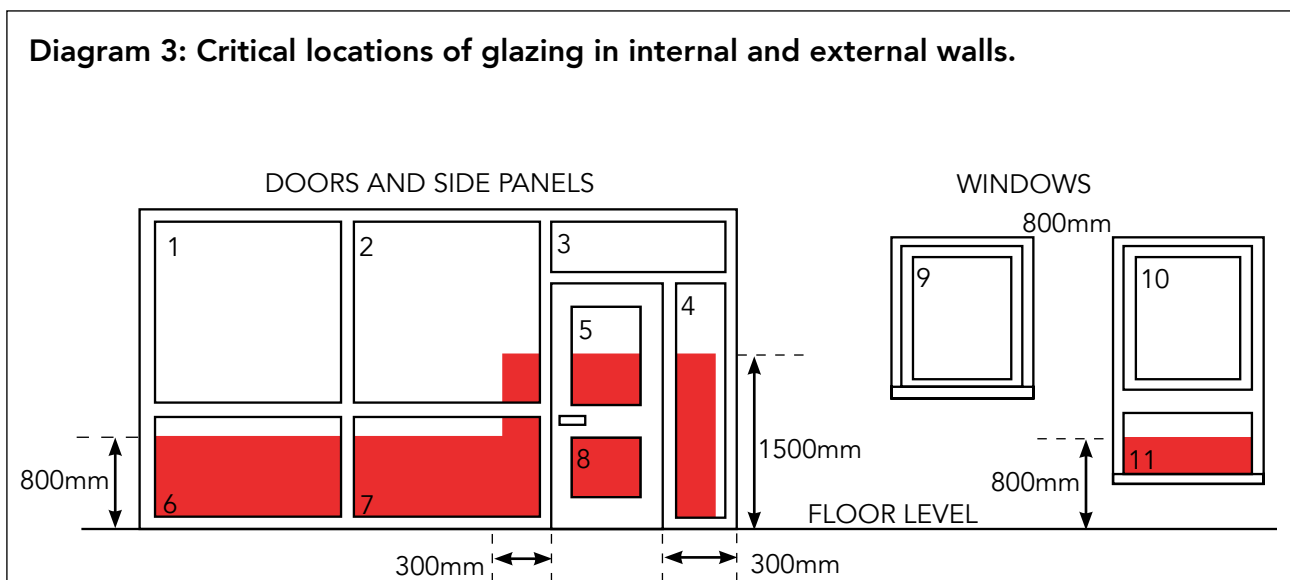

## Appendix 4: The design of escape windows

**Where window openings are proposed to be used for means of escape purposes the following guidance must be referred to.**

The window must have an unobstructed openable window area that is at least 0.33msq with at least the width and height dimension being a minimum of 450mm. Side hung opening lights are recommended. Care must be taken when considering the design (particularly with uPVC windows and their various hinge designs) to ensure the necessary openable area required is provided.

The bottom of the openable area (window sill level) must be not more than 1100mm, and not less than 800mm above floor level. Windows are suitable for means of escape where the drop from the window to ground level is one storey only (not exceeding 4.5m from first floor level to outside ground level).

**Note:** *The ground below the windows must be flat and free from hazards (low walls, railings etc).*

Where security is provided on windows, means of opening must be readily available within the room.

### Examples of acceptable escape window minimum dimensions.

Measurements in metres

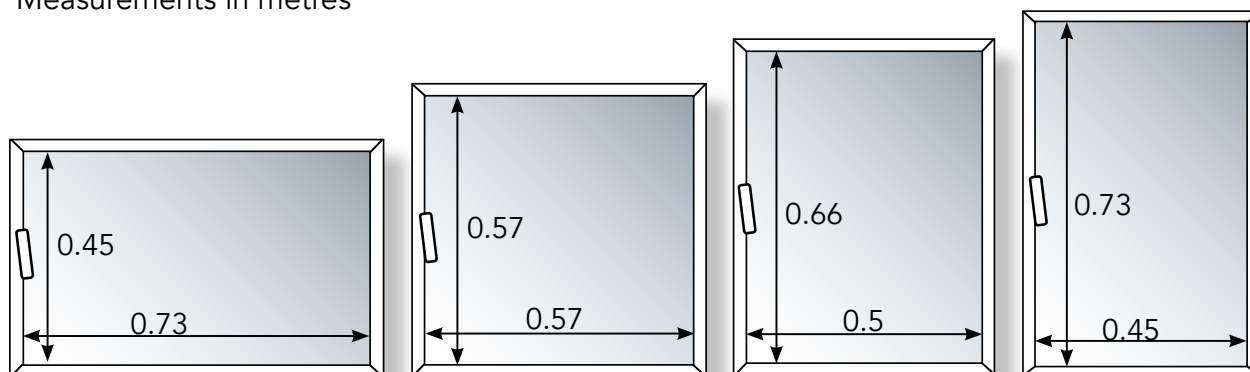

All of these windows have opening areas of 0.33 square metres.

## Appendix 5: Window security

1. Windows are a popular point of entry for burglars through breaking glass or just being left open. Windows certified to British Standard BS7950 Windows of Enhanced Security should be installed and laminated glass should be considered in ground floor and accessible windows such as those above a flat roof.
2. Locks should be used particularly on ground floor opening windows and easy to reach windows such as above a flat roof or near a drainpipe. If these locks are fitted with keys, these must be readily available to everyone in the property in the event of escape from fire.
3. Advice from the manufacturer must be taken when fitting locks to uPVC windows or it could affect your warranty; on wider transom windows the locks should be fitted to both sides of the window, and on larger casement windows they should be fitted to the top and bottom of the window.
4. Window frames need to be checked for signs of damp, wear or rot (wooden frames) or corrosion (metal frames) as this will reduce their security.

For further advice about window security please see **[www.securedbydesign.com](http://www.securedbydesign.com)**



## Appendix 6: Guidance on fire doors and frames

### Frames

- (i) Where new frames are provided the gap between the frame and wall should be infilled with suitable material to achieve 30 minutes fire resistance. The provision of architrave to cover gaps in this location will not provide the necessary fire resistance.

### Doors

- (i) Failure of fire resisting doors is very often due to burn through at the gap between door leaf and door frame. The fit of the door to frame is therefore extremely important and the gap should be as small as practical allowing the door to close freely. In the case of FD30 doors the gap should be 1 to 2mm. Where smoke seals are requested to be fitted (FD30S doors), the BS 9999:2008 standard requires FD30S doors to have a gap at the bottom of no more than 3mm and cannot drag on the carpet (preventing closure). If the gap is in excess of 3mm you will require a threshold cold smoke strip.

- (ii) Doors should be hung on 1½ pairs (3 no) of 100mm steel butt hinges.

- (iii) Doors referred to as FD30S are fire doors required to be fitted with both intumescent fire and flexible edge cold smoke seals along both vertical and top edges of the door.

Intumescent materials are materials which expand on exposure to high temperatures. In a fire an intumescent strip swells to form a close seal between the door and frame.

This slows down the spread of fire.

The cold smoke seal (perhaps more accurately described as a room-temperature seal) is designed to resist smoke penetration between the door and frame in the **early stages of a fire** only.

The positions for fitting seals in door leaves are shown in the diagrams on the opposite page.

Seals can be fitted in the frame and if so they should align with the centre of the door leaf. Manufacturers' instructions should be adhered to when fitting seals.

- (iv) Smoke seals must **NOT** be painted over as this reduces their flexibility and effectiveness.
- (v) Seals are not required to be fitted across the bottom of doors, but the threshold gap should not exceed 8mm.

### Ironmongery

- (i) Voids around the locking mechanism must be kept to a minimum and filled with intumescent paste or be encapsulated with a proprietary intumescent product.
- (ii) All doors required for means of escape must be capable of being opened from the inside without the use of a key (see Appendix 7 for door security).
- (iii) The door stop of the frame should not be cut away to facilitate any lock or latch.

**Diagram 1: Guidance on the fitting of combined fire and smoke seals**

(i) Cross section of combined fire and smoke seal

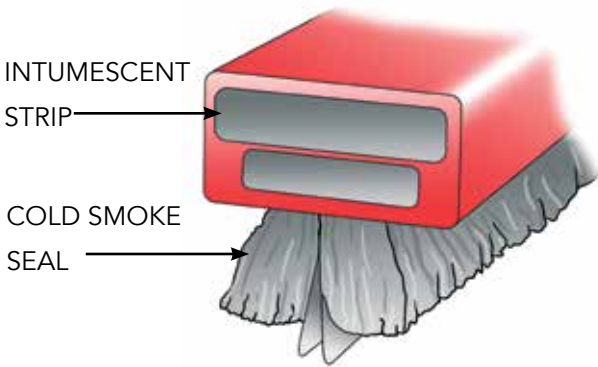

(ii) Position of seals fitted in door leaf (in both vertical edges and top edge of the door).

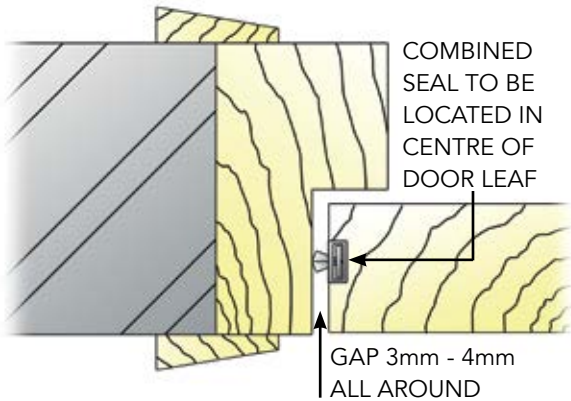

(iii) Position of seals fitted in frame (in both vertical edges and top edge of the frame).

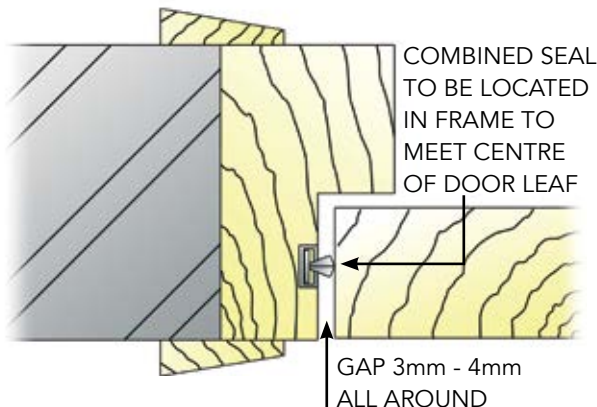

(iv) The door must be fitted with a self-closing device capable of closing the door into the frame from any angle. Hydraulic overhead closers conforming to current BSEN 1154 Fire Grade 1 (or equivalent) are preferable as they are more efficient and reliable.

**Note:** Some overhead closers are not suitable for use on fire doors so it is always best to check with the supplier or manufacturer before purchasing.

Where concealed closers are allowed on fire doors it is recommended that these should be of the double chain hydraulically powered type.

If your front and back doors are not secure, neither is your home: two thirds of burglars gain entry through a door. Remember, quality locks and bolts are only as strong as the door and the frame to which they are fitted.

### General Advice for all Doors

1. Wooden doors should be solid and at least 44mm (1<sup>3</sup>/<sub>4</sub>"") thick. Check that the frame is well fixed, and if weak or rotten replace it.
2. Laminated glass is recommended for glass panels in or around doors as these are especially vulnerable.
3. Remember to fit all security devices with strong screws or bolts.
4. Doors that open outwards are generally more secure than those that open inwards due to the method that would need to be used to force entry, but may not always be practical to fit e.g. if the door opens directly out onto the pavement. However, hinges are fitted on the side that the doors open, i.e. if your door opens outwards the hinges will be on the outside of the property and, therefore, potentially at risk from being removed and entry gained. In these cases, hinge bolts or security hinges should be used to reinforce the security of the door.
5. Before fitting locks to PVC or metal doors, check with the installer to make sure that this will not affect your warranty.
6. Patio doors should be fitted with an anti-lift device.

### Entrance/Exit Doors

These should be fitted to British Standard PAS 24-1 'Doors of Enhanced Security'. Bought as a complete kit, this shows that the door, frame, locks and fittings have been attack tested. PAS 24-1 doors will be fitted with a 5-lever mortice lock certified to either BS 3621 or BS 8621 standards. Very simply the BS 3621 is a deadlock that requires a key to open it from the inside, and the BS 8621 is fitted with a cylinder lock that incorporates a thumb turn release. To ensure escape from fire is not compromised it is recommended by both West Midlands Police and West Midlands Fire Service that BS 8621 mortice locks are fitted, but please note that security from burglary is rendered useless if installed onto doors which have unprotected glass in or next to them, or if the thumb turn can be reached by putting a hand through the letterbox.

*BS3621 and BS8621 have been developed from EN122209 which is the European standard for single point locking devices. The British Standards reflect the elements of EN12209 that are considered to be the minimum level required for insurance cover within the UK. The only difference between BS3621 and BS8621 is the level of security offered from the internal face of the door – BS8621 allowing the use of a non-key operated release (e.g. thumb turn).*

*NB PAS 24-1 doors will also be fitted with a rim latch lock (also called a night latch); these can generally be opened from the inside without a key and therefore do not*

*impede escape from fire. Where other locks are fitted that require a key, please ensure that these are not left in or near to the door for security reasons. Ensure that they are easily accessible to everyone in the property in the event of the need to escape from fire. For more information about door security and locks, please see [www.securedbydesign.com/guides/index.aspx](http://www.securedbydesign.com/guides/index.aspx) (go to SBD New Homes Section 2 Physical Security).*

### **Individual bed-sit/flat doors**

These doors are, in fact, your own front door and should have the same security safety standards. In addition it is recommended that they have no apertures or glazing.

## Appendix 8: The upgrading of floors and ceilings

The floor and ceiling construction between floor levels in any house in multiple occupation must be able to resist the spread of smoke and flame from any fire.

For most two storey houses it will be sufficient to achieve a nominal thirty minutes fire resistance whereas three or more storey properties will need to achieve a full thirty minutes fire resistance.

### 1. To achieve a nominal thirty minutes fire resistance

The condition of any lath and plaster ceiling should be examined in detail.

If there is any doubt regarding the condition of the lath and plaster then this should be replaced or underdrawn with 12.5mm plasterboard or fireline board.

Where the existing ceiling is in an acceptable condition, the floor above can be overboarded to achieve a nominal thirty minutes fire resistance, as follows:-

- (i) If the timber floorboards are square edged or poorly fitted tongue and groove boards, then the floor should be overlaid with 3.2mm oil tempered hardboard or 4mm plywood.
- (ii) Hardboard sheets should be conditioned before laying to prevent warping. The rough side (mesh side) should be sprayed or brushed with water and the wetted boards stacked rough side to rough side and left in the room where they are to be fixed, for a period of 48 hours before final fixing.
- (iii) Dependant upon the type of floor covering to be provided and the

manufacturers' instructions, the board may be laid rough or smooth side up.

- (iv) The boards should be fixed in place using 19mm hardboard nails or staples at 150mm centres around the perimeter of the boards and across the surface. Boards should be fixed in a staggered fashion as in brick bonding. Joints should coincide with joist positions.

### 2. Method of under-drawing a lath and plaster ceiling to achieve a full thirty minutes fire resistance

- (i) A layer of chicken wire should be first nailed below the existing ceiling directly into the floor joists or alternatively timber battens should be fixed beneath the ceiling at right angles to the joists (counter battens) by means of screw fixings through the existing ceiling directly into the floor joists.
- (ii) When a new plasterboard ceiling is to be fixed, allowance in the nail length should be made for penetrating the existing ceiling and chicken wire. Galvanised clout/plasterboard nails should be used and fixed at 150mm centres.
- (iii) Joints in the plasterboard should be scrimmed and a 3mm skim coat applied to the boards / trowelled to a smooth finish.

**Further information is available in Building Research Establishment Digest 208, "Increasing the Fire Resistance of Existing Timber Floors."**

Other specifications are available and reference can be made to manufacturers' detailed specifications, if supported by detailed fire test documentation.

## Appendix 9: Gas meters within a protected escape route

Where gas meters are situated within the enclosure of a single protected escape route (staircase/entrance hall) the following conditions should be met.

1. Lead pipes are unsatisfactory and the gas supply pipes should be of high melting point metal.

The meters should be checked by a competent person to ensure that the installation complies with the current Gas Safety (Installations and Use) Regulations.

2. Where security of gas meters is an issue then, to prevent unauthorised interference, the meters should be housed in a secure cupboard. The cupboard enclosure is not required to be a fire resisting cupboard.

The cupboard should be provided with ventilation grills at high and low levels.

All residents should be issued with a key to give access to meters 24 hours a day. The gas provider should be consulted to ensure they are satisfied with the arrangements as they will require access to read meters.

## Appendix 10: Automatic fire suppression systems

Since the late 1980s, there has been a growing acknowledgement that fire sprinklers, once found only in industrial and commercial premises, can significantly improve fire safety in residential type properties.

### General description

A water system is designed to cover a pre-determined floor area. Fire suppression system supply pipes are permanently charged with water, fed from the domestic water main or storage tanks. Fire suppression heads are fitted to the system of supply pipes, and each is an independent unit and operates only if a fire causes it to do so.

Suppression heads are fitted with small thermal elements that are activated solely by heat. The thermal element is set to operate at a fixed temperature, not less than 30°C

above ambient temperature, which makes it highly unlikely to operate other than in a fire condition. The exception is malicious operation and if the fire risk assessment indicates that this is likely, a water suppression system may not be appropriate. In the majority of fire just one suppression head is operated, which is often sufficient to deal with the fire.

### Potential uses

There is potential for water suppression systems to be fitted in all types of existing residential accommodation. The decision to do so will be based on:

- cost / benefits analysis of the overall benefit gained from the provision against the cost of installation and maintenance;
- the practicability of their installation;
- the extent of design freedoms available in terms of reduced compensatory provision

## Appendix 10: Automatic fire suppression systems

- of other fire safety measures; and
- their potential for fulfilling a need where traditional fire safety measures cannot be provided to the full recommended standard, for example, where extended travel distances cannot be reduced to the recommended maximum or where fire protecting lobbies cannot be installed.

When considering a water suppression system, regard must be paid to the adequacy of the water supply and mains water pressure. If interruptions to supplies are possible or the water pressure is low or fluctuates, the additional measures such as pumping or water storage may be required or indeed the installation may not be feasible.

### Potential design freedoms

Water suppression systems are not a fire safety solution in themselves. In isolation, they cannot provide an acceptable level of fire safety in residential accommodation to meet the requirements of current legislation. However, as part of a comprehensive overall fire risk assessment they can be a key component in the overall solution and can contribute to a safe building. In particular the provision of a suitable water suppression system can, allow for relaxed position on certain fire safety measures (but not all). Some examples of design freedoms which have been applied include reduced fire separation / compartmentation, an alternative to a secondary means of escape where impracticable, extended travel distances and relaxed requirements for inner rooms. However, the provision of automatic fire detection and warning systems cannot

be relaxed. These must still be provided, as adequate early warning of a fire is always essential.

These trade-offs or 'design freedoms' are not prescribed in any statutory guidance and must be agreed with the relevant housing authority, building control authority and fire and rescue authority for each individual case. Each case will have different factors and must be considered on its own merits. A blanket approach to the allowance of design freedoms should not be applied.

### Standards for water suppression systems

Where a water suppression system is agreed upon, its design, installation and maintenance should be in accordance with BS 9251:2005 or another equivalent standard by the enforcing authority. Approval of the type of system and its design should be sought from the enforcing authority prior to installation.

Installation should be carried out only by experienced sprinkler contractors who are suitably qualified and registered with an appropriate sprinkler association or third party accreditation scheme such as LPS 1048 scheme requirements for certified sprinkler installers, supervising bodies and supervised installers. The installer must provide information to the landlord as detailed in clause 6.3.2. of BS 9251:2005.

*More detailed guidance on water suppression systems can be found in "A guide to automatic water suppression systems (AWSS) and their practical application" (Chief Fire Officers Association).*

## Appendix 11: Perimeter security

It is important to secure the space around your property.

### **Front**

Where possible the front of the property would benefit from a small wall or gate to define the property's boundaries, but make sure that passers-by can still see the front of your home so that a burglar can't work without being seen. Front rooms benefit from net curtains or blinds so that no one can see what it is actually in the room.

### **Side/side alley-gates**

A large percentage of HMOs, particularly student houses, are in terraced housing where access can be gained to the rear by means of a side alley between two properties in a group of, for example, 4-6 houses. As most burglaries are committed once access has been gained to the rear often through these side alleys, it is important that these are securely gated. These gates should be lockable and ideally steel railed (in order that a potential offender can still be seen from the road), and preferably installed in line with the front of the property.

Wherever possible exiting through these alley gates onto the streets should not require a key (for example a keypad or push button system that cannot be reached from the other side of the gate), however this is often not cost effective or practical. West Midlands Fire Service advises that escape from premises to a back garden or yard is considered to be a place of only relative safety. It must then be possible for persons escaping to move to a point well

away from the building, where they will not be affected by heat or smoke from any fire. Only then will they be considered to be in a place of ultimate safety. This position must be achievable without the assistance of the Fire Service. Where keys are required to open these gates it is important that they are managed and held by all that need them (e.g. occupants, and landlords/letting agents).

### **Rear garden/yard**

1. The rear of the property would benefit from being over-looked by neighbours.
2. Identify this private space with fences, gates, walls or planting. A thorny/prickly hedge along the boundary of your property can put thieves off. Fencing or walls should be at least 2m high, and trellis topping also makes climbing difficult.
3. Consider putting gravel down as this creates noise to walk on.
4. Security lighting should make offenders feel vulnerable and observed, should illuminate high risk areas and allow occupiers to see persons approaching (but it should not cause light pollution, annoy neighbours or blind occupiers from identifying callers).



## Appendix 12: Basements

Basement rooms are a special consideration. This is because:

- in any basement fire, hot noxious gases and smoke from combustion will travel upwards due to convection and may prejudice the escape route and occupants on the ground floor;
- a fire in the basement may weaken the structure of the floor above it and endanger occupants and any fire officer entering the building to search and rescue;
- escape routes from basement rooms may be limited as significant proportions of the walls are underground.

The following is guidance on the provisions required in a “normal” risk situation. All these requirements are subject to your risk assessment.

### **Bedsit-type HMOs:**

There should be full 30 minute fire-resisting construction separating the basement from the ground floor. This will include the basement ceiling, doors between the basement and ground floors and the walls surrounding the stairwell.

In particular, the sloping ceiling and the triangular partition often forming the surrounding walls to the basement stairwell should be 30 minutes fire-resisting. Appendices 3, 6 and 8 provide details on how this can be achieved.

Within the basement, walls, ceilings and doors should be of the same standard as required in the rest of the house.

Fire detection and alarm equipment should also be of the same standard as in the rest of the house.

Ideally, there should be a separate means of escape from the basement to an ultimate place of safety. If this is not practicable, then escape windows should be provided to all habitable rooms. See Appendix 4 for details of escape window design.

As habitable rooms in basements must, in any case, be provided with adequate natural lighting, it is usually possible to provide escape windows by adaptation, replacement or conversion.

Where a proper escape exit or escape windows cannot be provided, it may be possible to rely on the stairwell escape route to ground floor level. This would be subject to the findings of your risk assessment and discussions with your local Council's Fire Safety Enforcement Officer.

### **Shared houses:**

Most of the requirements are the same as for bedsit type HMOs. However, if the house is a shared house (see page 7) and has no more than two storeys above the basement, then where fire separation is concerned, it will usually be possible to accept existing construction providing it is robust and has sound plastered walls and ceilings and well-fitted solid doors.

### **Unoccupied basements:**

There must be fire detection in the basement linked in with the system serving the floors above.

## Appendix 12: Basements

There is no requirement for a separate means of escape in unoccupied basements.

However, for bedsit type properties, although unoccupied, it is still a requirement that the basement be separated from the floors above with 30 minute fire-resisting construction.

The ceiling and stairwell enclosure (including the door) MUST be 30 minute fire resisting.

Again, there is a relaxation for shared houses with no more than two floors above the basement. Existing sound traditional construction is acceptable provided the basement is well managed. It must be kept tidy, with a minimum of stored combustible material.

### Summary of basement fire precaution requirements

	30 minute fire-resisting walls / ceilings separating upper floors	30 minute fire-resisting doors separating upper floors	Fire detection linked to rest of house	Escape window	Firefighting equipment
<b>Basement bedsits</b>	Required	Required	Required	Required if no separate basement fire exit	Required if cooking equipment in basement
<b>Basement shared houses with maximum two floors above</b>	Not required if sound traditional construction	Not required if sound traditional construction	Required	Required if no separate basement fire exit	Required if cooking equipment in basement
<b>Unoccupied basements with bedsits above</b>	Required	Required	Required	Not required	Not required
<b>Unoccupied basements: shared houses with maximum two floors above</b>	Not required if basement tidy and well managed	Not required if basement tidy and well managed	Required	Required	Not required



## Recording of Significant Findings from the Fire Risk Assessment (Homestamp form H2)

Record of Significant Findings from the Fire Risk Assessment			
Risk Assessment for:		Assessment undertaken by:	
Address:		Completed by:	
		Signature:	
Postcode:		Date:	
Floor unit (for large multi-unit properties)		Property type:	
Step 1: Identify fire hazards			
Sources of ignition:			
Sources of fuel:			
Step 2: People at risk:			
Step 3: Evaluate, remove, reduce and protect from risk			
3.1 Evaluate the risk of the fire occurring			
3.2 Evaluate the risk to people from a fire starting at the premises			
3.3 Remove or reduce the hazards that may cause a fire			
3.4 Remove and reduce the remaining risks to people from a fire			
Assessment Review			
Next review date:			
Risk assessment completed by:			
Signature:			
<b>Review outcome</b> (where substantial changes have occurred a new record sheet should be used)			
Notes:			
1. This risk assessment record of significant findings should refer to other plans, records or documents as necessary.			
2. The information in this record should assist you to develop an emergency plan, co-ordinate measures with any other 'responsible persons' in the building, train any staff and inform residents.			
<small>© Homestamp 2009 supplied with <b>A Guide to Fire and Security Protection in Multi-Occupied Residential Premises.</b>                      To download go to <a href="http://www.homestamp.com">www.homestamp.com</a> <b>Form H2</b></small>			













## Events other than false alarms or maintenance work

(Homestamp form H8)

<b>Events other than false alarms or maintenance work</b>									
Date	Time	Event e.g. fire, test, alarm, fault	Zone (where applicable)	Device (where applicable)	Action (where applicable)	Date completed (where applicable)	Signature		









# Homestamp Consortium

Partners signed up to the Homestamp Consortium include the following list. Organisations continue to join us, so please look on our website for the latest list of partners.



[www.homestamp.com](http://www.homestamp.com)

## Homestamp Consortium

Highfield House Business Centre,  
1562-1564 Stratford Road, Hall Green,  
Birmingham B28 9HA.

Tel: 0121 288 2008

Email: [talk@homestamp.com](mailto:talk@homestamp.com)



Follow us on Twitter: @homestamp

### Association of Residential Letting Agents

[www.arla.co.uk](http://www.arla.co.uk)

### Birmingham City Council

[www.birmingham.gov.uk](http://www.birmingham.gov.uk)

### Birmingham City University

[www.bcu.ac.uk](http://www.bcu.ac.uk)

### Bromsgrove District Council

[www.bromsgrove.gov.uk](http://www.bromsgrove.gov.uk)

### Coventry City Council

[www.coventry.gov.uk](http://www.coventry.gov.uk)

### Dudley Metropolitan Borough Council

[www.dudley.gov.uk](http://www.dudley.gov.uk)

### Herefordshire Council

[www.herefordshire.gov.uk](http://www.herefordshire.gov.uk)

### Lichfield County Council

[www.lichfield.gov.uk](http://www.lichfield.gov.uk)

### National Landlords Association

[www.landlords.org.uk](http://www.landlords.org.uk)

### Redditch Borough Council

[www.redditchbc.gov.uk](http://www.redditchbc.gov.uk)

### Residential Landlords Association

[www.rla.org.uk](http://www.rla.org.uk)

### Sandwell Metropolitan Borough Council

[www.sandwell.gov.uk](http://www.sandwell.gov.uk)

### Solihull Metropolitan Borough Council

[www.solihull.gov.uk](http://www.solihull.gov.uk)

### Stafford Borough Council

[www.staffordbc.gov.uk](http://www.staffordbc.gov.uk)

### Stratford-On-Avon District Council

[www.stratford.gov.uk](http://www.stratford.gov.uk)

### City of Stoke on Trent

[www.stoke.gov.uk](http://www.stoke.gov.uk)

### Telford & Wrekin Council

[www.telford.gov.uk](http://www.telford.gov.uk)

### University of Birmingham

[www.bham.ac.uk](http://www.bham.ac.uk)

### Walsall Council

[www.walsall.gov.uk](http://www.walsall.gov.uk)

### Warwick District Council

[www.warwickdc.gov.uk](http://www.warwickdc.gov.uk)

### West Midlands Fire Service

[www.wmfs.net](http://www.wmfs.net)

### West Midlands Police

[www.west-midlands.police.uk](http://www.west-midlands.police.uk)

### Wolverhampton City Council

[www.wolverhampton.gov.uk](http://www.wolverhampton.gov.uk)

### Wychavon District Council

[www.wychavon.gov.uk](http://www.wychavon.gov.uk)

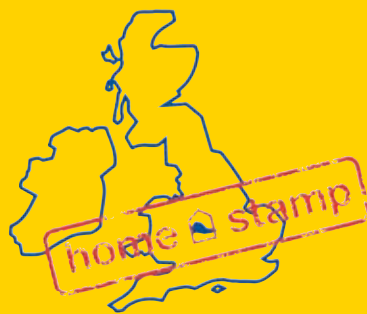

[www.homestamp.com](http://www.homestamp.com)



Scan with your smartphone  
for further information at  
[www.homestamp.com](http://www.homestamp.com)



Follow us on Twitter  
@ homestamp